

Mobile Crane/Grue mobile

LTM 1300-6.2



360 USt



256 ft



308 ft



374 ft

LIEBHERR

Table of content

Tables des matières

Technical Data/Caractéristiques technique

Dimensions/Encombrement	3
Mobile Crane/Grue mobile	4 – 5
Fuel saving and noise reduction/Economie de carburant et réduction du bruit	6 – 7
Variable boom systems/Systèmes de flèche variables	8 – 10
VarioBase®/VarioBase®	11
Fast, efficient set-up process/Un montage d'équipement rapide et efficace	12 – 13
Boom/jib combinations/Configurations de flèche	14 – 16
Weights/Poids Working speeds/Vitesses	17
Counterweight/Contrepoids	18 – 19
T	20 – 27
TK	28 – 44
TNZK	45 – 61
TF	62 – 71
TN	72 – 89
Equipment/Equipement	90 – 91
Description of symbols/Explication des symboles	92 – 93
Remarks/Remarques	94

Dimensions Encombrement

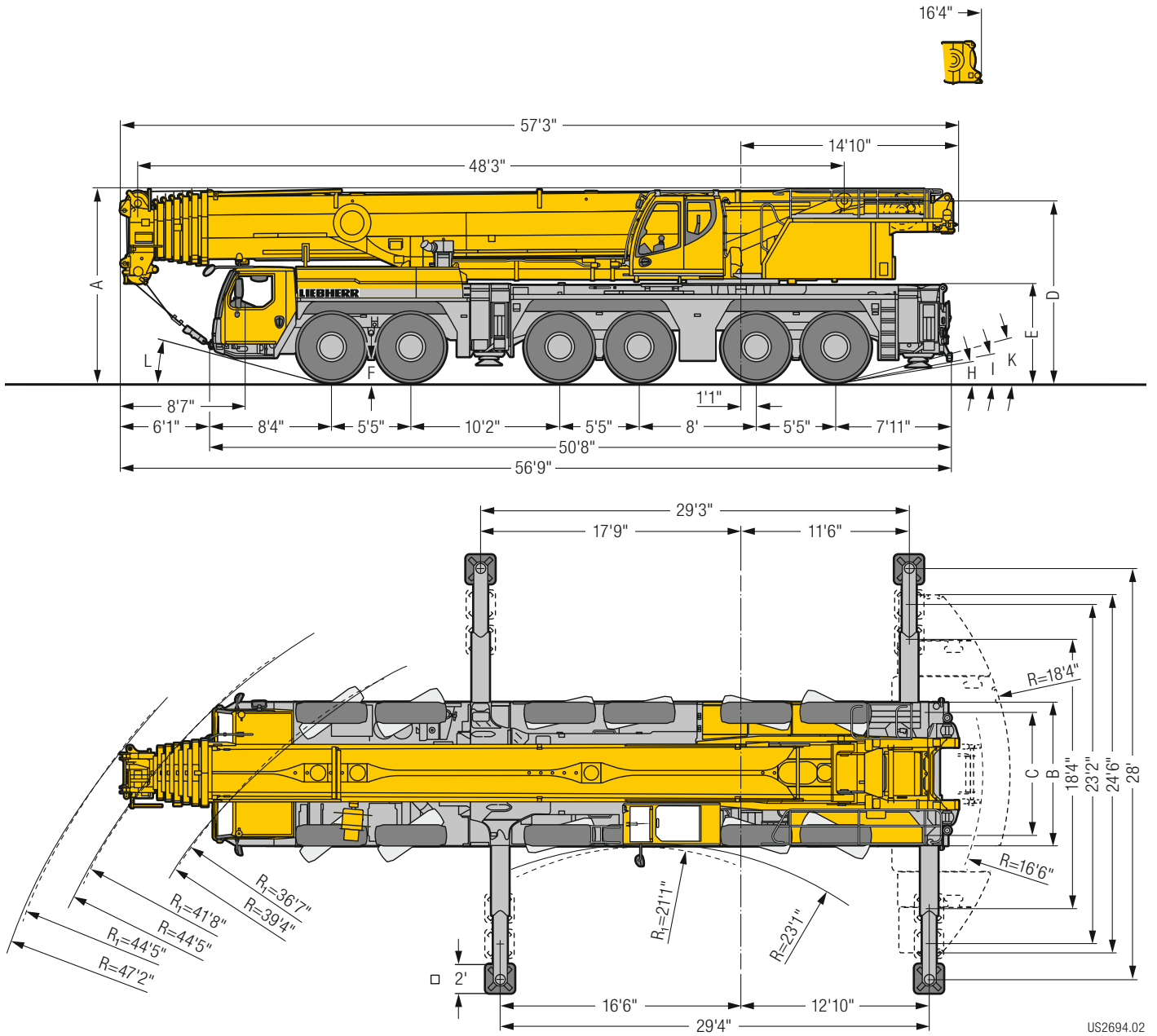

US2694.02

R_i = All-wheel steering · Direction toutes roues ¹⁾ only with VarioBase® · seulement avec VarioBase®

Dimensions/Encombrement

	A	A	B	C	D	E	F	H	I	K	L
		5" *									
445/95 R 25 (16.00 R 25)	13'1"	12'9"	9'10"	8'4"	12'3"	6'7"	1'4"	9°	10°	15°	14°
525/80 R 25 (20.5 R 25)	13'1"	12'9"	10'2"	8'5"	12'3"	6'7"	1'4"	9°	10°	15°	14°

* lowered · abaissé

Mobile Crane/Grue mobile

LTM 1300-6.2



256 ft



18 ft – 115 ft



57 ft – 230 ft



46 ft – 138 ft



211,600 lbs

€COmode

€COdrive

TRAXON

Torque

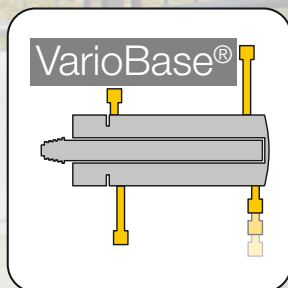

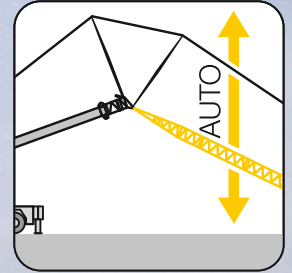
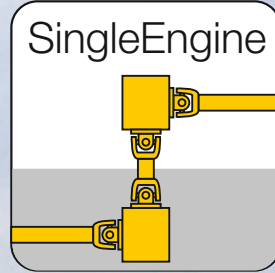
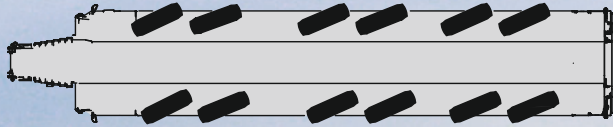

Fuel saving and noise reduction

Economie de carburant et réduction du bruit

Liebherr-8-cylinder engine
455 kW / 619 h.p.

€COdrive
TRAXON
Torque

Driving strategy in the carrier with ECO- or Powermode to reduce noise and fuel

L'adaptation du mode de déplacement avec le mode ECO ou le mode Puissance permet de réduire le niveau sonore et la consommation de carburant

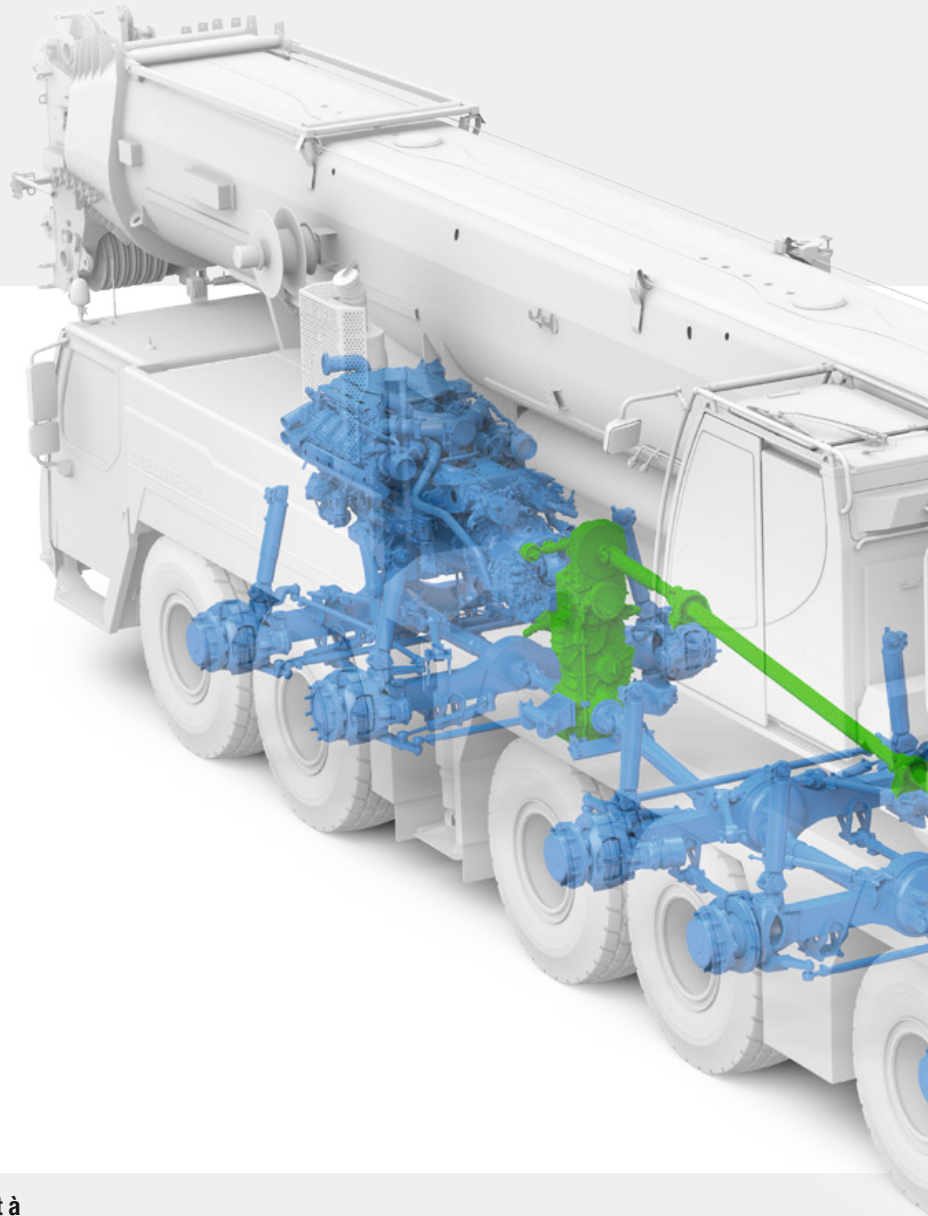

Innovative One-Engine-Concept

- Drive from chassis engine via a mechanical shaft with special high efficiency factor
- Increased effectiveness and reduced maintenance expenditure

Concept innovant à moteur unique

- Entraînement du moteur du châssis par le biais d'un arbre mécanique particulièrement performant
- Rentabilité accrue et entretien nettement réduit

ZF-TraXon Tourque

Automated shift gearbox with torque converter, 12 forward gears, 2 reverse gears

ZF-TraXon Tourque

Boîte de vitesses automatisée avec convertisseur de couple, 12 vitesses avant, 2 vitesses arrière.

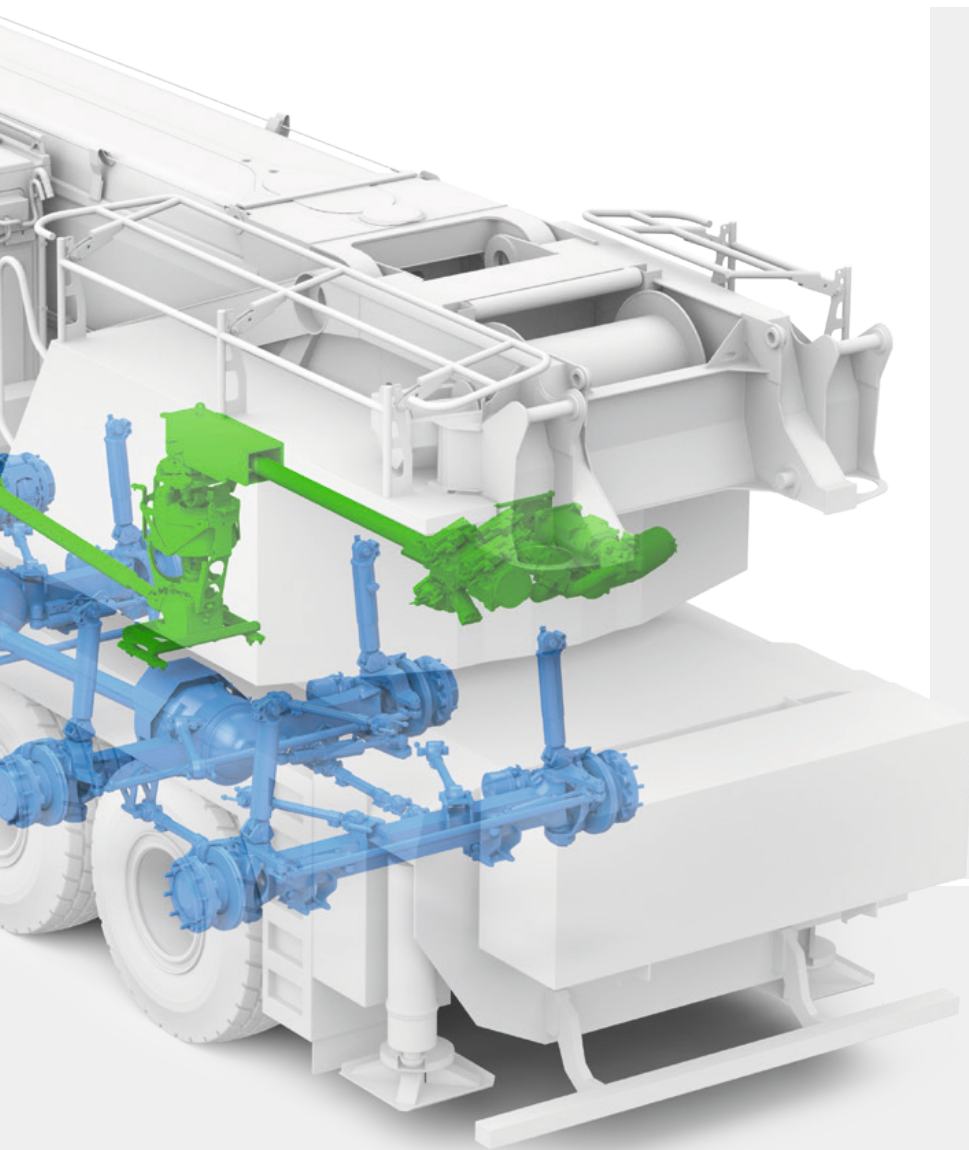

€COmode

Reduced fuel consumption due to automatic disengaging of the complete pump drive at engine idling

Réduction de la consommation de carburant par désengagement automatique de l'entraînement complet de la pompe en mode ralenti

Variable boom systems

Systèmes de flèche variables

**TK
TNZK**

TF

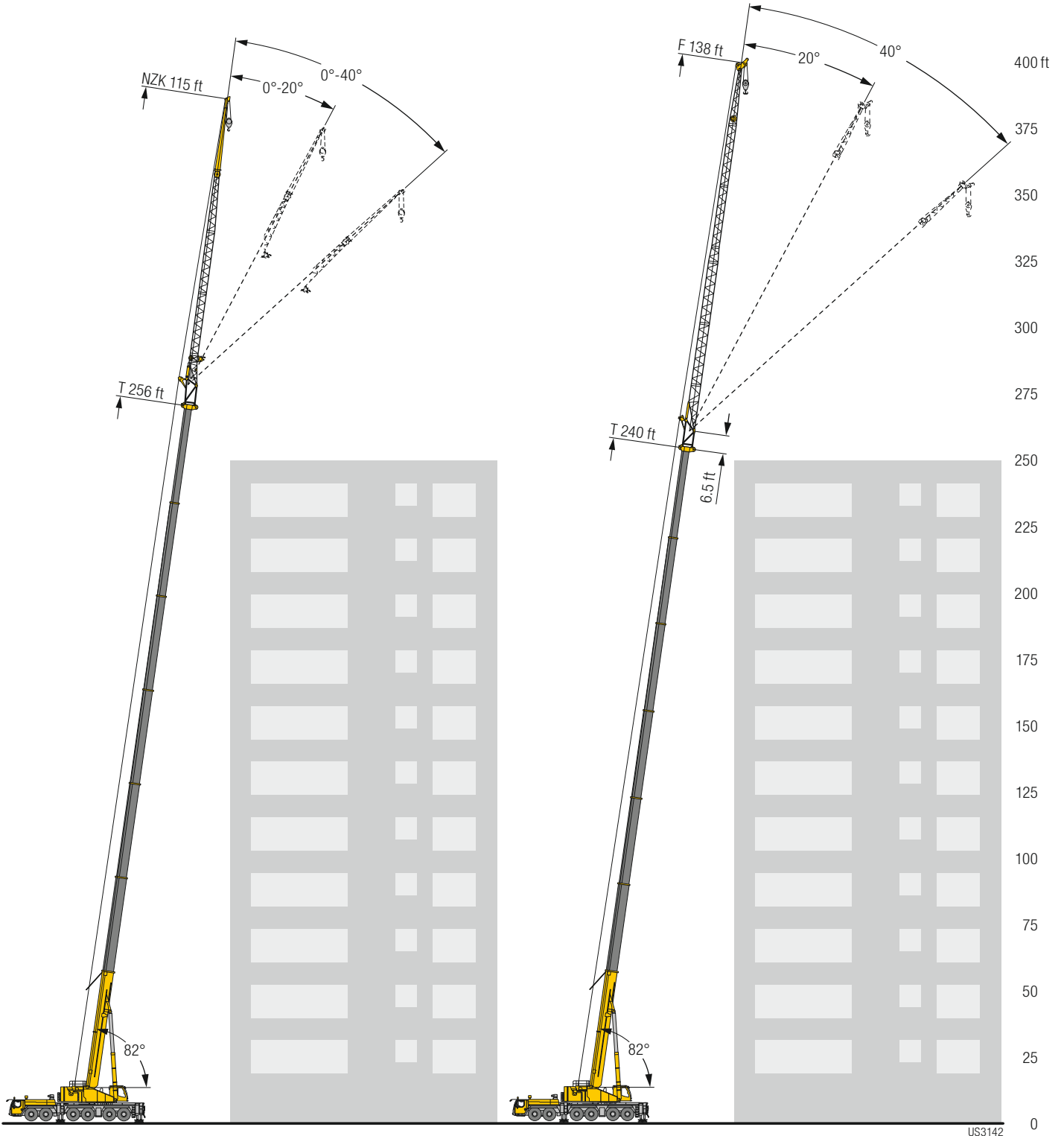

US3142

Hose drum for hydraulic cylinder
Tambour à flexible pour le vérin hydraulique

TNZK



18 ft integral erection jib, hydraulically adjustable
Flèche de montage intégrée de 18 ft de long, à réglage hydraulique

**TK
TNZK**



Self-assembly of the fixed jib
Montage autonome de la flèche fixe

TF

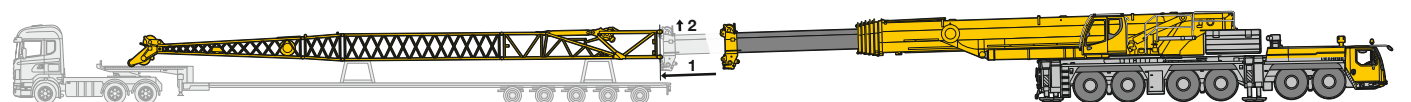

Variable boom systems

Systèmes de flèche variables

TN

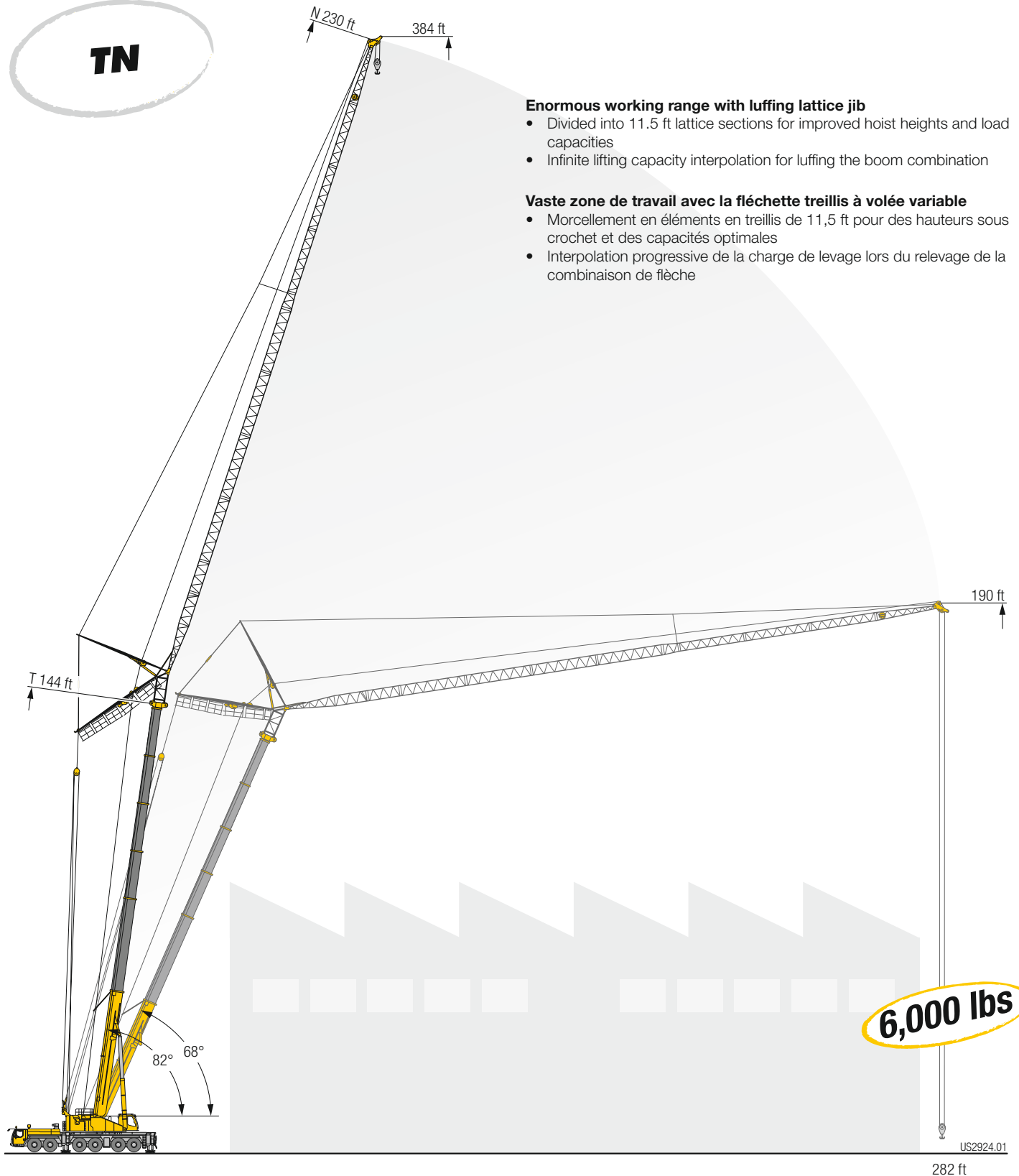

Enormous working range with luffing lattice jib

- Divided into 11.5 ft lattice sections for improved hoist heights and load capacities
- Infinite lifting capacity interpolation for luffing the boom combination

Vaste zone de travail avec la fléchette treillis à volée variable

- Morcellement en éléments en treillis de 11,5 ft pour des hauteurs sous crochet et des capacités optimales
- Interpolation progressive de la charge de levage lors du relevage de la combinaison de flèche

Infinite lifting capacity interpolation · Interpolation progressive de la charge de levage

VarioBase® / VarioBase®

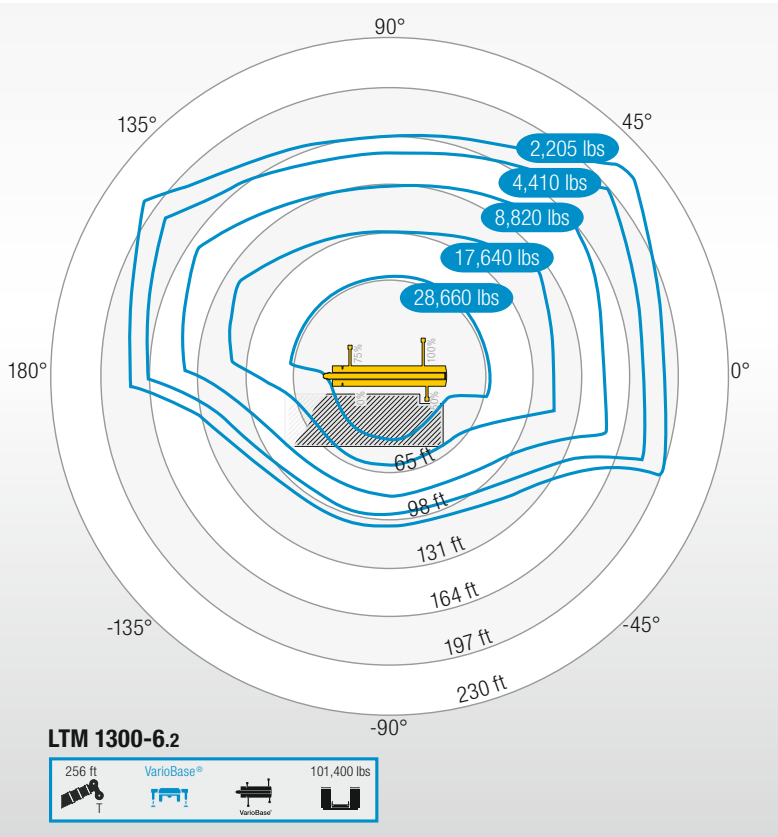

Greater safety in constricted working conditions
Plus de sécurité dans les zones de travail étroites

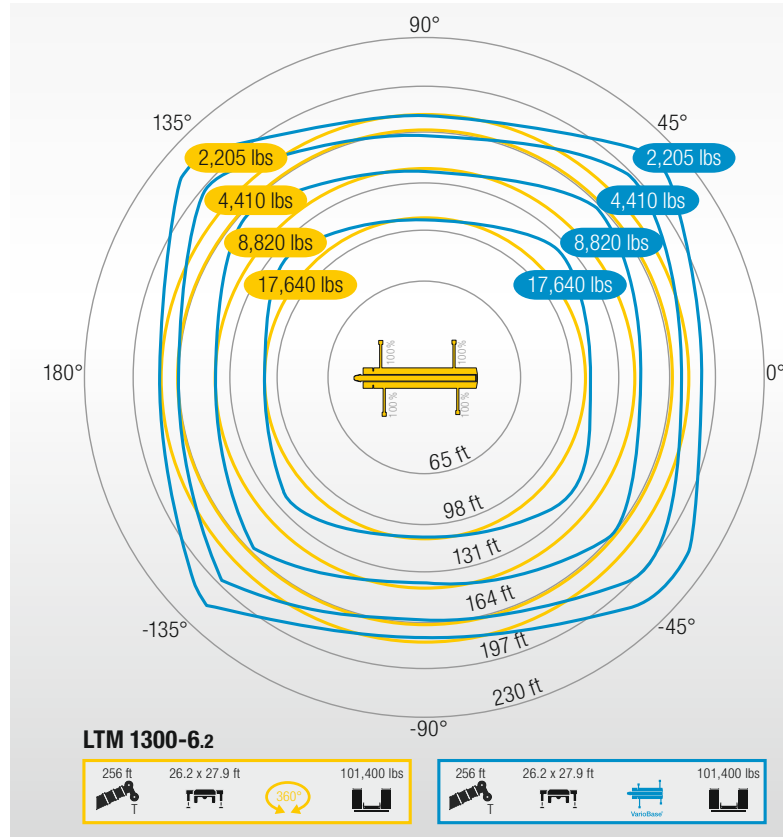

Higher lifting capacity and larger working range
Une capacité plus importante et une zone de travail plus large

Greater safety

The maximum lifting capacities are calculated individually and precisely for every situation. This ensures safe working practice with any chosen support base. The LTM 1300-6.2 has securing positions at 0%, 50%, 75% and 100%.

Sécurité accrue

Les charges autorisées sont calculées individuellement et en fonction de la situation actuelle. Les opérations sont ainsi sécurisées avec chaque base de calage au choix. La LTM 1300-6.2 dispose de positions de verrouillage à 0%, 50%, 75% et 100%.

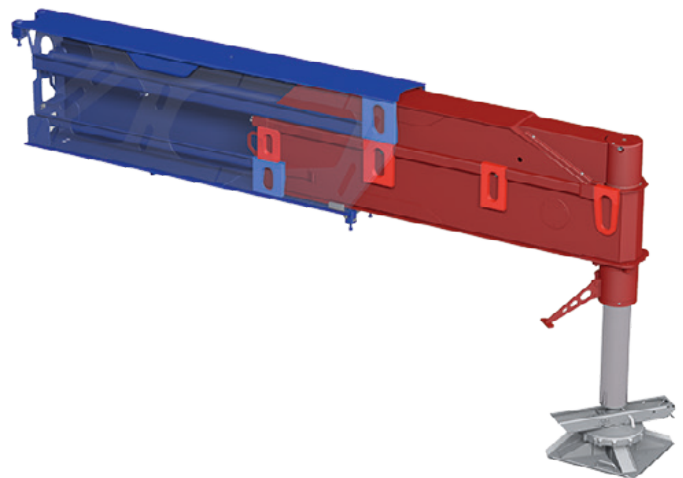

Fast, efficient set-up process Un montage d'équipement rapide et efficace



1



2



3



4

- 1) Winch 2 secured to the ballast plate · Treuil 2 fixé sur la plaque de lest
- 2) Winch 2 is moved hydraulically towards the turntable frame · Treuil 2 replié hydrauliquement vers le cadre de partie tournante
- 3) The pulley block is moved towards winch 2 using BTT · Palonnier de renvoi rabattu vers le treuil 2 avec le BTT
- 4) Winch 2 is installed · Treuil 2 monté

Self-assembly of winch 2

The self-installation device on winch 2 ensures high efficiency. The winch can be installed without an additional crane in a matter of minutes. The remote control using the BTT Bluetooth Terminal is extremely convenient and provides clear lines of sight for the installation process.

Treuil 2 à montage autonome

Le dispositif de montage autonome sur le treuil 2 assure un rentabilité élevée. Le treuil peut être monté sans grue externe et avec peu d'opérations manuelles. La commande à distance avec le terminal Bluetooth BTT est extrêmement confortable et garantit une vue dégagée de la procédure de montage.



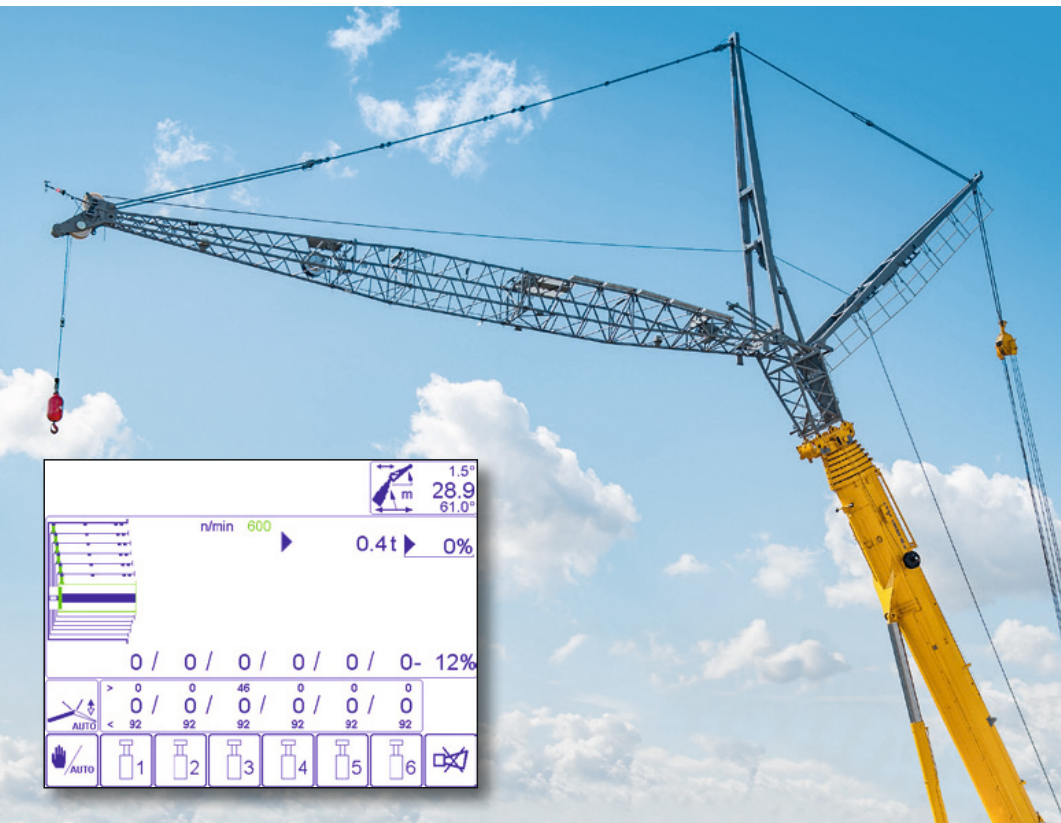





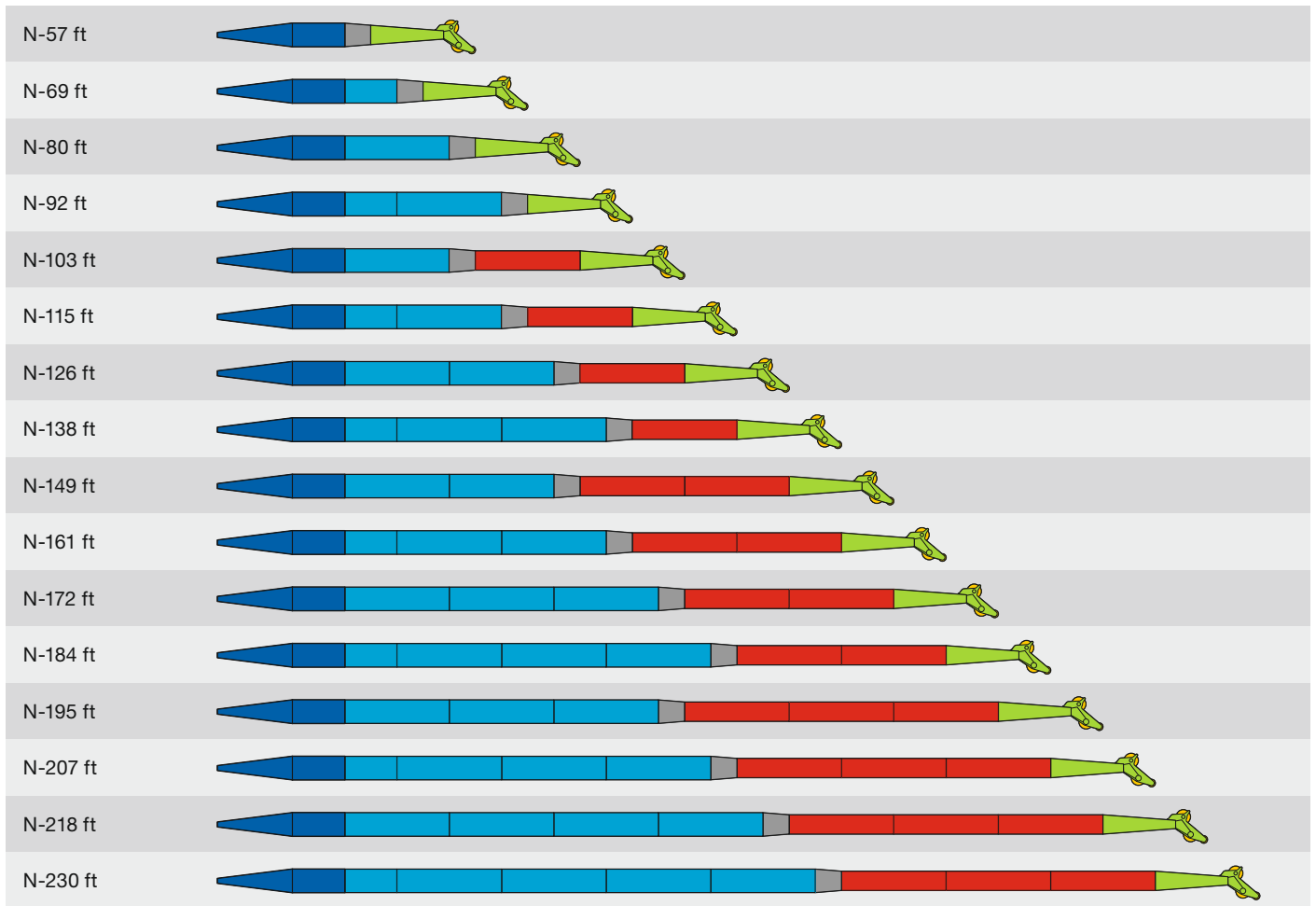

Automised erection of the luffing jib. Dead easy operation relieves the crane driver and caters for increased safety
 Relevage automatisé de la fléchette à volée variable – un jeu d'enfant et une sécurité accrue pour le grutier

Automatic ballasting by pressing a button
 Lestage automatique par simple pression d'un bouton

Boom/jib combinations - Luffing fly jib Configurations de flèche - Fléchette à volée variable

TN



-  28'8" N-shaped base section · Élément de base N
-  NA-11'6"
-  NA-23'
-  5'9" NI reduction section · Élément réducteur NI
-  NI-23'
-  23' N head section · Élément de tête N







US2750

Boom/jib combinations - Fixed fly jib

Configurations de flèche - Fléchette fixe



F-46 ft	
F-57 ft	
F-69 ft	
F-80 ft	
F-92 ft	
F-103 ft	
F-115 ft	
F-126 ft	
F-138 ft	

-  17'3" N-shaped base section · Élément de base N
-  NA-23'
-  NA-11'6"
-  5'9" NI reduction section · Élément réducteur NI
-  NI-23'
-  23' N head section · Élément de tête N

US2749

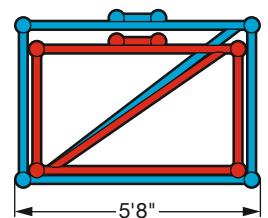
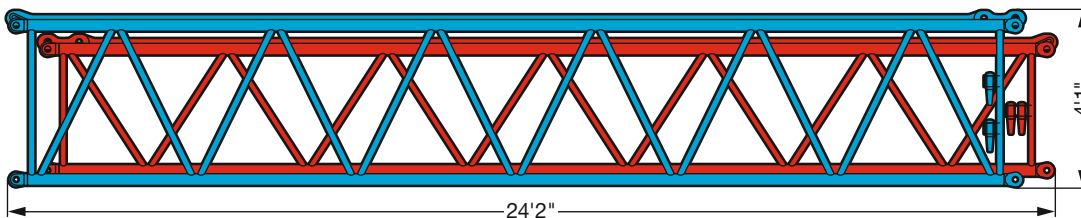

US2888

Boom/jib combinations Configurations de flèche

- T** Telescopic boom/Flèche télescopique
- K** Swing away jib/Flechette pliante
- NZK** Hydraulic swing away jib
Fléchette pliante hydraulique/Falcone idraulico
- F** Fixed lattice jib/Fléchette treillis fixe
- N** Luffing fly jib/Flechette treillis à volée variable



T

TK/TNZK

TF

TN



20 – 27

28 – 61

62 – 71

72 – 89

S2729.01

Weights Poids



Hook block/Moufles à crochet

403,450	12	17	7,500
343,920	7	14	3,300
275,600	5	11	3,530
176,400	3	7	3,200
79,800	1	3	2,200
26,900	–	1	1,100

Working speeds Vitesses

Crane carrier/Châssis porteur



	min.	max.	%	
445/95 R 25 (16.00 R 25) 525/80 R 25 (20.5 R 25)	2.13	85	50.7 %	12 / R2

Theoretical gradeability / Aptitude théorique en pente

Crane superstructure/Partie tournante

	max			F
	0 – 427 ft/min single line ft/min au brin simple	0.9"	984 ft	27,420 lbs
	0 – 427 ft/min single line ft/min au brin simple	0.9"	1525 ft	27,420 lbs
	0 – 1.6 rpm			
	approx. 80 seconds to reach 82° boom angle env. 80 s jusqu'à 82°			
	approx. 800 seconds for boom extension from 48 ft – 256 ft env. 800 s pour passer de 48 ft – 256 ft			

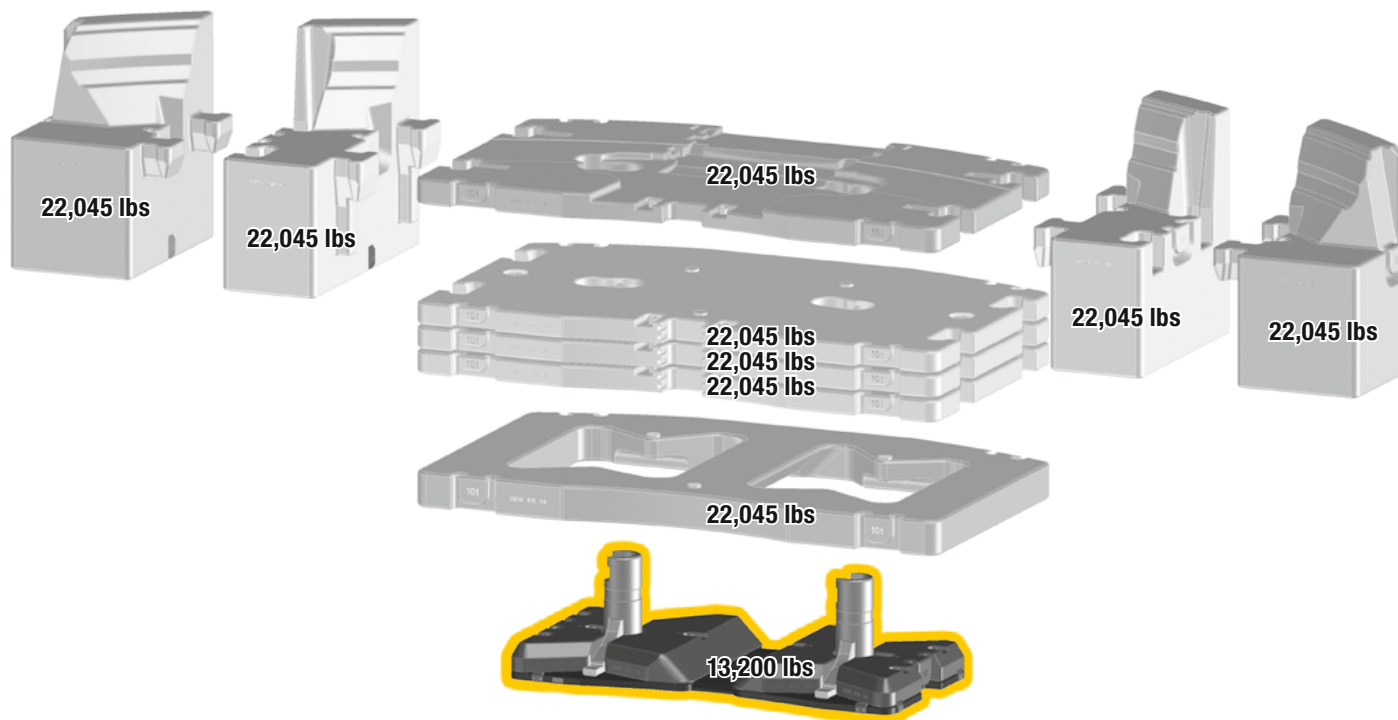

Counterweight Contrepoids

211,600 lbs



Technically transportable · Transport techniquement simplifié

Axle/Essieu

	1	2	3	4	5	6	
lbs	26,400	26,400	26,400	26,400	26,400	26,400	158,400 lbs ¹⁾

¹⁾ with sheave set · avec jeu de poulies

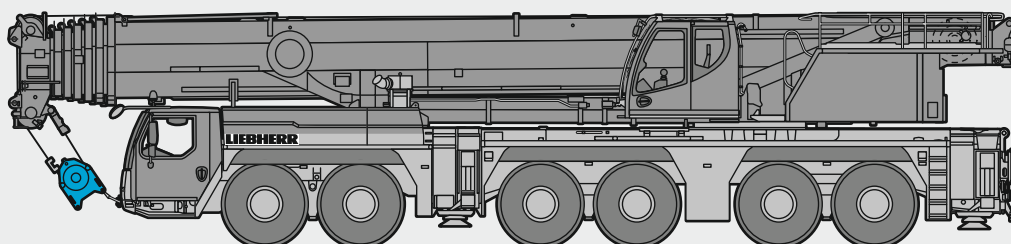

S3134

UK Counterweight - Option Contrepoids

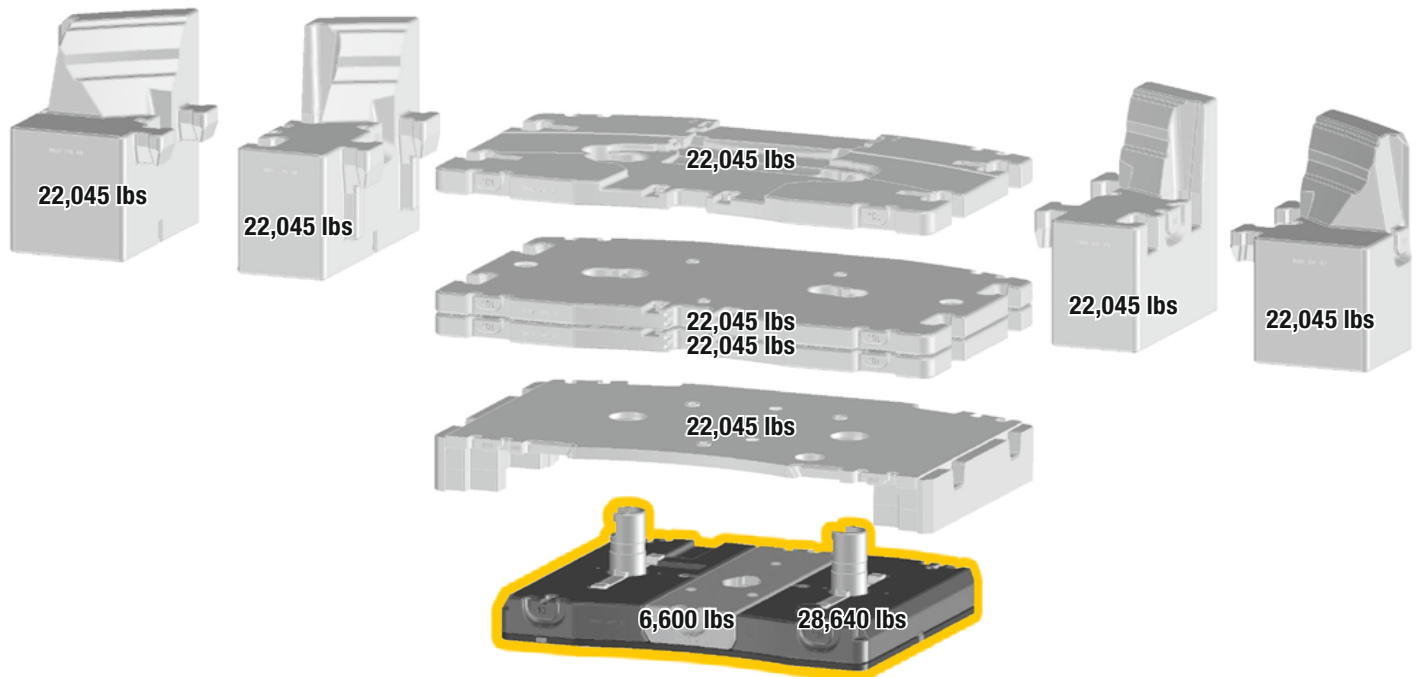
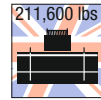

Technically transportable - Transport techniquement simplifié

Lifting capacities Forces de levage

T



	48 ft		64 ft	80 ft	96 ft	112 ft	128 ft	144 ft	160 ft	176 ft	192 ft	208 ft	224 ft	240 ft	253 ft	256 ft	
	*																
10	661.4	298.6															10
11	504.2	298.6	298.6														11
12	403.4	298.6	298.6	298.6													12
13	385.2	298.6	298.6	298.6													13
14	365.9	298.6	298.6	298.6													14
15	349.7	298.6	298.6	298.6	248.3	191.2											15
16	332.8	298.6	298.6	290.6	247.8	198.4											16
17	318	297.3	296.2	279.6	246.7	198											17
18	307.3	293.5	287.2	272.7	245.5	197.6											18
19	297.7	284.4	278.8	264.2	244.2	197.1	159.8										19
20	288.4	274.8	270.9	256.3	241.9	196.2	159.3										20
22	271.3	256.4	257.1	241.9	230.3	194.3	158.3	130.2									22
24	255	239.4	241.2	229.6	217.8	192.3	157.4	129.7									24
26	235.7	223	225	218.6	206.8	190.4	156.4	129.2	102.1								26
28	218.2	208.6	210.6	208	197	186.8	155.4	128.6	101.9								28
30	202.9	195.8	197.7	197.6	188.3	182.4	154.4	128	101.6	82.1							30
32	189.4	184.2	186.1	186.5	180.4	174.6	153.2	127.4	101.2	82							32
34	177.5	173.3	175.3	175.9	172.7	167.5	151.9	126.8	100.9	81.8	66.1						34
36	166.8	163.6	165.4	166.1	165.2	161.1	150.5	126.1	100.5	81.5	65.8						36
38	156	154.6	156.5	157.2	156.6	155.1	147.1	125.1	99.1	81.1	65.6	54.1					38
40	130.5	130.5	148	148.7	148.1	148.7	142.2	123.9	97.6	80.6	65.4	53.9					40
45			130	130.1	132.1	131.7	129.4	120.6	92.3	78.6	64.6	53.4	43.6				45
50			115.9	117.4	117.5	116.6	115.2	114.3	86.4	75.4	63.3	52.9	43.3	36.5	30.3		50
55			96.1	105.1	105.2	104.3	104.9	104.3	81.2	71.2	61.2	52.1	42.5	36.1	30.1	29.3	55
60				94.8	94.8	93.9	96.1	94.5	76.2	67.3	58.4	50.5	41.5	35.4	29.9	29.2	60
65				85.7	85.7	84.7	86.9	85.4	71.5	63.5	55.5	48.5	40.4	34.6	29.4	28.8	65
70				74.2	77.9	78.8	79.1	77.6	67.3	59.8	52.8	46.5	39.1	33.7	28.8	28.4	70
75					71.1	73.3	72.3	70.8	63.3	56.2	50.1	44.5	37.8	32.7	28	27.7	75
80					65.3	67.4	66.4	64.8	59.6	53.1	47.5	42.6	36.5	31.6	27.1	26.8	80
85					60.7	62.2	61.2	59.6	56.2	50.1	45.1	40.6	35.3	30.5	26.3	26	85
90						57.6	56.6	55	52.8	47.3	42.9	38.7	34	29.5	25.4	25.2	90
95						53.6	52.5	50.9	49.3	44.9	40.7	36.9	32.8	28.6	24.6	24.4	95
100						49.3	48.8	47.2	45.7	42.5	38.6	35.2	31.6	27.6	23.8	23.6	100
105						25.6	45.5	43.9	43.4	40.1	36.8	33.6	30.5	26.7	23	22.9	105
110							42.5	40.9	41.9	38.1	34.9	32.1	29.3	25.7	22.3	22.2	110
115							39.5	38.1	39.7	36	33.1	30.6	28.2	25	21.5	21.5	115
120							27.2	36.9	37.2	33.6	31.5	29.2	27.1	24.2	20.9	20.8	120
125								35.9	34.9	32.1	30.1	27.9	26	23.4	20.2	20.2	125
130								34.3	32.7	30.7	28.6	26.5	25	22.6	19.6	19.6	130
135								24.2	30.7	28.7	27.1	25.4	23.9	22	19	19	135
140									28.9	26.9	25.4	24.2	22.9	21.3	18.4	18.4	140
145									27	25.9	24.3	23.1	22	20.6	17.8	17.7	145
150									21.8	25.2	23.3	22.1	21.1	20	17.3	17.1	150
155										24.7	22.4	21.1	20.2	19.3	16.7	16.5	155
160										23.4	21.1	19.8	19.3	18.6	16.2	15.8	160
165										18.6	19.8	19.1	18.5	17.9	15.6	15.2	165
170											19.1	18.4	17.8	17.2	15.1	14.6	170
175											18.7	17.8	16.9	16.5	14.6	14	175
180											15.3	17.1	16	15.9	14.2	13.3	180
185												16.2	15.5	15.3	13.7	12.7	185
190												15.3	15	14.6	13.2	12.2	190
195												13.2	14.6	13.9	12.8	11.6	195
200												5.4	14.2	13	12.3	11.1	200
205													13.5	12.2	11.9	10.6	205
210													10.3	11.4	11.4	10.1	210
215													4.7	10.7	10.9	9.6	215
220														9.9	10.2	9.2	220
225														7.2	9.5	8.7	225
230															8.8	8.3	230
235															7.6	7.9	235
240															4.8	5.9	240

* over rear - en arrière

t_240_001_50001_00_000 / 001_50301_00_000

Lifting capacities

Forces de levage

T

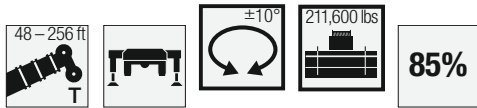

	48 ft	64 ft	80 ft	96 ft	112 ft	128 ft	144 ft	160 ft	176 ft	192 ft	208 ft	224 ft	240 ft	253 ft	256 ft	
10	298.6															10
11	298.6	298.6														11
12	298.6	298.6	298.6													12
13	298.6	298.6	298.6													13
14	298.6	298.6	298.6													14
15	298.6	298.6	298.6	248.3	191.2											15
16	298.6	298.6	290.6	247.8	198.4											16
17	298.6	296.2	279.6	246.7	198											17
18	298.6	287.2	272.7	245.5	197.6											18
19	294.9	278.8	264.2	244.2	197.1	159.8										19
20	288.4	270.9	256.3	241.9	196.2	159.3										20
22	271.3	257.2	241.9	230.3	194.3	158.3	130.2									22
24	255	242.8	229.6	217.8	192.3	157.4	129.7									24
26	235.7	230.1	218.6	206.8	190.4	156.4	129.2	102.1								26
28	218.2	218.3	208	197	186.8	155.4	128.6	101.9								28
30	202.9	205.1	198	188.3	182.4	154.4	128	101.6	82.1							30
32	189.4	191.5	188.9	180.4	174.6	153.2	127.4	101.2	82							32
34	177.5	179.5	179.5	172.7	167.5	151.9	126.8	100.9	81.8	66.1						34
36	166.8	168.7	169.5	165.2	161.1	150.5	126.1	100.5	81.5	65.8						36
38	156	159.1	159.8	158.1	155.1	147.1	125.1	99.1	81.1	65.6	54.1					38
40	130.5	150.5	151.1	150.6	149.2	142.2	123.9	97.6	80.6	65.4	53.9					40
45		131.9	132.6	132.2	133.9	130.1	120.6	92.3	78.6	64.6	53.4	43.6				45
50		118.4	117.6	119.9	119	117.7	115.2	86.4	75.4	63.3	52.9	43.3	36.5	30.3		50
55		96.1	107.6	107.6	106.8	105.5	106.9	81.2	71.2	61.2	52.1	42.5	36.1	30.1	29.3	55
60			97.3	97.4	96.5	98	97.1	76.2	67.3	58.4	50.5	41.5	35.4	29.9	29.2	60
65			88.4	88.4	87.4	89.6	88.1	71.5	63.5	55.5	48.5	40.4	34.6	29.4	28.8	65
70			74.2	80.6	79.6	81.8	80.3	67.3	59.8	52.8	46.5	39.1	33.7	28.8	28.4	70
75				73.8	74	74.9	73.5	63.3	56.2	50.1	44.5	37.8	32.7	28	27.7	75
80				68	69.8	69	67.5	59.6	53.1	47.5	42.6	36.5	31.6	27.1	26.8	80
85				60.7	64.8	63.8	62.2	56.2	50.1	45.1	40.6	35.3	30.5	26.3	26	85
90					60.2	59.1	57.6	52.8	47.3	42.9	38.7	34	29.5	25.4	25.2	90
95					56.1	55	53.4	49.5	44.9	40.7	36.9	32.8	28.6	24.6	24.4	95
100					49.3	51.3	49.7	46.9	42.5	38.6	35.2	31.6	27.6	23.8	23.6	100
105					25.6	47.9	46.3	44.3	40.1	36.8	33.6	30.5	26.7	23	22.9	105
110						44.9	43.2	41.9	38.1	34.9	32.1	29.3	25.7	22.3	22.2	110
115						39.6	40.4	40.6	36.2	33.1	30.6	28.2	25	21.5	21.5	115
120						27.2	37.9	39.2	34.4	31.5	29.2	27.1	24.2	20.9	20.8	120
125							35.9	37	32.7	30.1	27.9	26	23.4	20.2	20.2	125
130							34.7	34.9	31.1	28.6	26.5	25	22.6	19.6	19.6	130
135							24.2	32.9	29.3	27.2	25.4	23.9	22	19	19	135
140								31	27.9	26	24.2	22.9	21.3	18.4	18.4	140
145								27.5	26.8	24.8	23.1	22	20.6	17.8	17.7	145
150								21.8	25.6	23.6	22.1	21.1	20	17.3	17.1	150
155									24.7	22.6	21.1	20.2	19.3	16.7	16.5	155
160									24	21.6	20.2	19.3	18.6	16.2	15.8	160
165									18.6	20.8	19.3	18.5	17.9	15.6	15.2	165
170										20	18.5	17.8	17.2	15.1	14.6	170
175										18.7	17.8	17	16.5	14.6	14	175
180										15.3	17.2	16.3	15.9	14.2	13.3	180
185											16.6	15.6	15.3	13.7	12.7	185
190											15.7	15	14.6	13.2	12.2	190
195											13.2	14.6	14	12.8	11.6	195
200											5.4	14.2	13.5	12.3	11.1	200
205												13.7	13	11.9	10.6	205
210												10.3	12.5	11.4	10.1	210
215												4.7	11.8	11	9.6	215
220													10.3	10.6	9.2	220
225													7.2	10.2	8.7	225
230														9.6	8.3	230
235														7.6	7.9	235
240														4.8	5.9	240

t_240_001_50201_00_000

Lifting capacities

Forces de levage

T



	48 ft	64 ft	80 ft	96 ft	112 ft	128 ft	144 ft	160 ft	176 ft	192 ft	208 ft	224 ft	240 ft	253 ft	256 ft		
10	298.6															10	
11	298.6	298.6														11	
12	298.6	298.6	298.6													12	
13	298.6	298.6	298.6													13	
14	298.6	298.6	298.6													14	
15	298.6	298.6	298.6	248.3	191.2											15	
16	298.6	298.6	290.6	247.8	198.4											16	
17	294.7	296.2	279.6	246.7	198											17	
18	283.8	284.5	272.7	245.5	197.6											18	
19	272.1	272.9	264.2	244.2	197.1	159.8										19	
20	260.7	262.7	256.3	241.9	196.2	159.3										20	
22	239.6	241.8	241.8	230.3	194.3	158.3	130.2									22	
24	220.5	222.6	223.1	217.7	192.3	157.4	129.7									24	
26	202.5	204.9	205.8	204.4	190.4	156.4	129.2	102.1								26	
28	187	189.3	190.1	189.2	186	155.4	128.6	101.9								28	
30	173.4	176.4	176.2	178.5	173.9	154.4	128	101.6	82.1							30	
32	160.9	164.8	166.5	166.7	162.4	152.7	127.4	101.2	82							32	
34	149.3	153.3	155.1	155.4	152.1	145.3	126.8	100.9	81.8	66.1						34	
36	139.1	142.9	144.9	144.8	143	136.7	126.1	100.5	81.5	65.8						36	
38	130	133.8	135.7	135.9	134.6	131.9	124.2	99.1	81.1	65.6	54.1					38	
40	121.9	125.7	127.4	127.6	126.6	126	120.3	97.6	80.6	65.4	53.9					40	
45		108.4	110.2	110.2	111.7	110.3	104.3	92.3	78.6	64.6	53.4	43.6				45	
50		93.2	95.2	96.8	98.1	96.2	90.7	85.3	75.4	63.3	52.9	43.3	36.5	30.3		50	
55		79.9	81.9	85.1	84.8	83.7	79.6	75.8	70.9	61.2	52.1	42.5	36.1	30.1	29.3	55	
60			73	74.1	73.8	72.7	70.9	67.8	63.7	58.4	50.5	41.5	35.4	29.9	29.2	60	
65			64.4	65.2	64.9	63.7	62.5	61.4	58	54.3	48.5	40.4	34.6	29.4	28.8	65	
70			57.2	57.9	57.6	56.5	56.5	56.5	52.6	48.8	46	39.1	33.7	28.8	28.4	70	
75				51.8	51.5	50.3	52	50.6	47.3	45.9	42.7	37.8	32.7	28	27.7	75	
80				46.7	46.3	46.8	47.2	45.4	42.7	41.8	38.6	36.5	31.6	27.1	26.8	80	
85				42.4	41.9	43.9	42.7	40.9	39.9	37.9	36	34.3	30.5	26.3	26	85	
90					38.6	40	38.8	37.5	37.7	34.5	34.1	31.7	29.5	25.4	25.2	90	
95					36.9	36.6	35.4	34.3	34.7	32.7	31.6	29.1	28.5	24.6	24.4	95	
100					34.2	33.7	32.4	32.8	31.7	30.9	28.9	28	27	23.8	23.6	100	
105					25.6	31	30.1	30.7	29.1	29.4	27.1	26.5	25.1	23	22.9	105	
110						28.6	28.3	28.3	27.2	27	25.9	24.7	23	22	22	110	
115						26.5	27.2	26.2	26	24.8	24.4	22.8	21.1	20.6	20.3	115	
120						24.7	25.4	24.2	24.4	22.9	22.9	21.1	19.4	19	18.7	120	
125							23.6	22.3	22.6	22	21.2	19.5	17.8	17.4	17.1	125	
130								22	21.5	20.8	20.6	19.4	18	16.3	16	15.7	130
135								20.5	20.5	19.2	19.1	17.8	16.6	14.9	14.7	14.4	135
140									19	18	17.6	16.4	15.3	13.6	13.4	13.1	140
145									17.7	16.7	16.2	15	14	12.4	12.3	12	145
150									16.6	15.5	15	13.8	12.8	11.3	11.2	10.9	150
155										14.4	13.9	12.6	11.6	10.1	10.2	9.9	155
160										13.4	12.8	11.5	10.5	9.1	9.2	8.9	160
165										12.4	11.8	10.6	9.5	8.1	8.3	8	165
170											10.9	9.6	8.6	7.1	7.4	7.2	170
175											10	8.8	7.7	6.2	6.5	6.3	175
180											9.2	7.9	6.9	5.4	5.7	5.4	180
185												7.2	6.1	4.7	4.9	4.7	185
190												6.5	5.4	3.9	4.2	4	190
195												5.8	4.7		3.5		195
200												5.2	4.1				200
205													3.5				205

t_240_001_00303_00_000

Lifting capacities

Forces de levage

T

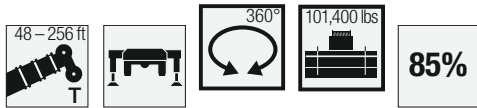

	48 ft	64 ft	80 ft	96 ft	112 ft	128 ft	144 ft	160 ft	176 ft	192 ft	208 ft	224 ft	240 ft	253 ft	256 ft	
10	298.6															10
11	298.6	298.6														11
12	298.6	298.6	298.6													12
13	298.6	298.6	298.6													13
14	298.6	298.6	298.6													14
15	298.6	298.6	298.6	248.3	191.2											15
16	297.4	298.5	290.6	247.8	198.4											16
17	291.7	291.9	279.6	246.7	198											17
18	278.6	279.1	272.7	245.5	197.6											18
19	266.3	267.7	264.2	244.2	197.1	159.8										19
20	254.5	256.7	255.4	241.9	196.2	159.3										20
22	232	234.6	234.7	229.8	194.3	158.3	130.2									22
24	211.7	214.2	214.6	212.1	192.3	157.4	129.7									24
26	194.3	196.7	197.6	196	189.4	156.4	129.2	102.1								26
28	178.8	182.7	182	184.5	176.8	155.4	128.6	101.9								28
30	164.3	168.5	170.2	170.1	164.3	153.3	128	101.6	82.1							30
32	151.7	155.8	157.4	157.9	152.9	144.8	127.4	101.2	82							32
34	140.6	144.6	146.5	146.7	141.3	137.9	126.8	100.9	81.8	66.1						34
36	130.9	134.8	136.7	136.6	131.1	129	120.6	100.5	81.5	65.8						36
38	122.1	126	128	128.1	125.3	120.1	112.7	99.1	81.1	65.6	54.1					38
40	113.4	117.7	119.7	119.7	118.7	112.1	105.2	96.5	80.6	65.4	53.9					40
45		97.1	99.5	102.8	101.1	95.5	89.7	85.8	78.6	64.6	53.4	43.6				45
50		82.2	85.2	86.5	86.1	82.8	78.3	74.2	70	63.3	52.9	43.3	36.5	30.3		50
55		69.8	72.9	73.9	73.6	72.1	69.7	67.1	63.2	58.9	52.1	42.5	36.1	30.1	29.3	55
60			63.1	64	63.7	62.6	62	60.4	55.9	53.4	49.4	41.5	35.4	29.9	29.2	60
65			55.2	56.1	55.7	55.5	56.7	53.8	50.3	48.2	44.2	40.4	34.6	29.4	28.8	65
70			48.8	49.6	49.2	51.2	50.2	48.1	45.9	42.9	40.7	38.9	33.7	28.8	28.4	70
75				44.2	44.9	45.9	44.8	43.5	42.5	39.7	38.1	35	32.7	28	27.7	75
80				39.6	41.8	41.3	40.1	39.2	39	36.6	34.5	32.7	31.4	27.1	26.8	80
85				35.8	37.8	37.3	36.8	36.9	35.3	34.2	32.3	30.7	29	26.2	26	85
90					34.4	33.9	33.6	33.7	32.4	31.4	30.3	28.4	26.5	25.2	24.7	90
95					31.4	30.9	31.7	30.6	30.8	28.7	28	25.8	24	23.5	23.1	95
100					28.8	28.2	29.1	28	28.1	27.2	25.6	23.6	21.8	21.3	20.9	100
105					25.6	26.9	26.7	26.5	25.8	25.6	23.5	21.5	19.8	19.4	19	105
110						25.2	24.6	24.7	23.6	23.5	21.6	19.7	18	17.6	17.2	110
115						23.3	22.7	22.8	21.9	21.4	19.8	17.9	16.3	16	15.6	115
120						21.6	21	21	20	19.6	18.2	16.4	14.8	14.5	14.2	120
125							19.4	19.3	18.4	17.9	16.6	15	13.3	13.1	12.7	125
130							17.9	17.8	16.8	16.3	15.1	13.6	12	11.8	11.5	130
135							16.6	16.4	15.4	14.9	13.7	12.4	10.8	10.6	10.3	135
140								15.1	14.1	13.7	12.4	11.3	9.7	9.5	9.2	140
145								13.9	12.9	12.5	11.2	10.2	8.6	8.5	8.2	145
150								12.9	11.9	11.3	10.1	9.1	7.6	7.5	7.2	150
155									10.9	10.3	9.1	8.1	6.6	6.6	6.3	155
160									10	9.4	8.1	7.1	5.7	5.8	5.5	160
165									9.1	8.5	7.3	6.2	4.8	5	4.7	165
170										7.7	6.4	5.4	3.9	4.2	3.8	170
175										6.9	5.7	4.6				175
180										6.2	5	3.9				180
185											4.3					185
190											3.7					190

L240_001_00304_00_000

Lifting capacities

Forces de levage

T



	48 ft	64 ft	80 ft	96 ft	112 ft	128 ft	144 ft	160 ft	176 ft	192 ft	208 ft	224 ft	240 ft	253 ft	256 ft	
10	298.6															10
11	298.6	298.6														11
12	298.6	298.6	298.6													12
13	298.6	298.6	298.6													13
14	298.5	298.6	298.4													14
15	298.1	297.5	292.7	248.3	191.2											15
16	282.9	283.2	280.1	245.7	198.4											16
17	266.1	267.9	266.3	238.9	198											17
18	250.9	253	248.3	223.7	197.4											18
19	236.9	239.5	228.1	205.5	192.6	159.8										19
20	223.4	225.6	210.3	194.2	178.2	155.7										20
22	198.6	196.3	184.6	168.9	160.3	146.5	130									22
24	177.7	171.1	159.4	152.6	141	129.2	118.1									24
26	154.6	148.2	140	134.8	125.2	115.2	107.2	98								26
28	134	130	127.6	120.3	112.1	104.6	97.9	92.6								28
30	114.8	117.5	114	108.1	101.2	96.1	92.1	84.5	75.5							30
32	99.3	105.3	102.7	98.4	92	88.6	84.2	77.6	72.2							32
34	87	94.5	93.5	89.6	84.8	83.1	77.4	71.8	67	59.2						34
36	76.8	84.2	85.4	81.8	78.3	76.8	71.4	66.2	63.3	58.4						36
38	68.4	75.6	78.3	75.5	74.3	71.1	67.2	63	59.8	56.2	50.1					38
40	61.4	68.3	71.8	69.7	69.8	66	62.8	60	56.1	53.3	47.9					40
45		54	57.5	60.6	58.6	55.5	54.8	51.5	49.5	46.9	43.4	39.3				45
50		43.8	47.2	50.2	49.8	49.2	47.1	45.5	42.8	40.7	37.1	33.4	31.1	29.4		50
55		36.1	39.4	42.2	42.6	43	41	39.4	36.8	34.9	31.7	28.3	26.2	25	24.4	55
60			33.2	35.9	36.7	37.3	35.4	34.1	31.9	30.1	27.2	24.2	22.2	21.2	20.7	60
65			28.1	30.9	31.6	32.5	30.9	29.7	27.6	26.1	23.4	20.7	18.7	18	17.6	65
70			23.6	26.5	27.3	28.2	27	26	24	22.6	20.3	17.7	15.7	15.3	14.8	70
75				22.9	23.6	24.6	23.8	22.8	20.9	19.6	17.4	15.2	13	12.9	12.5	75
80				19.7	20.4	21.4	20.9	20	18.2	17.1	15	12.9	10.7	10.6	10.3	80
85				17	17.6	18.6	18.2	17.6	15.9	14.9	12.9	10.9	8.7	8.6	8.3	85
90					15.3	16.2	15.8	15.5	13.8	12.9	10.9	9.1	6.7	6.8	6.3	90
95					13.2	14.2	13.8	13.6	12	11.1	9.2	7.4	4.8	4.9	4.4	95
100					11.5	12.3	11.9	11.8	10.4	9.5	7.6	5.7				100
105					10	10.7	10.3	10.2	9	8	6.2	4				105
110						9.3	8.9	8.7	7.6	6.7	4.6					110
115						8.1	7.6	7.4	6.4	5.5						115
120						7	6.4	6.3	5.3	4.1						120
125							5.4	5.2	4							125
130								4.5	4.2							130
135								3.7								135

t_240_001_00307_00_000

Lifting capacities

Forces de levage

T



	48 ft	64 ft	80 ft	96 ft	112 ft	128 ft	144 ft	160 ft	176 ft	192 ft	208 ft	224 ft	240 ft	253 ft	256 ft	
10	298.6															10
11	298.6	298.6														11
12	298.6	298.6	298.6													12
13	298.6	298.6	298.6													13
14	295.3	297.5	297.6													14
15	286.2	288.4	267.6	233.8	191											15
16	270.2	271.7	246.9	216.2	195.4											16
17	253.2	248.9	221.5	197.5	177.9											17
18	236.5	224.3	204.9	183.2	166.9											18
19	220.5	203.2	185.6	172.5	155.6	139.4										19
20	201.6	186.2	168.8	158.6	143.8	129.3										20
22	163	153.7	146.1	135.1	123.7	113.4	100.4									22
24	135.6	132.5	125.8	117.3	108	102.8	95.4									24
26	115	114.1	110.2	103.1	96.2	92.8	85.2	76.9								26
28	99.1	99.6	97	91.5	89.2	83.4	78.2	72.4								28
30	85.6	87.9	86.2	83.1	80.6	75.4	70.8	66.9	60.6							30
32	73.3	78.2	77.2	76.5	73.1	68.5	66.4	61.4	58.3							32
34	63.6	70	70	70.1	66.6	64	60.7	57.9	53.6	47.5						34
36	55.6	62.9	63.5	63.8	60.9	59.5	56	52.8	49.1	45.9						36
38	49	56.1	57.4	58.2	55.5	54.4	51.3	48.5	45	42.1	37.8					38
40	42.7	50.3	52	53	51.3	50	47.1	44.7	41.3	38.7	35.3					40
45		37.9	41.2	42.6	41.6	40.9	38.6	36.7	33.9	31.7	28.7	25.2				45
50		29.1	33	35	34.3	34	32.1	30.5	28	26.1	23.5	20.5	17.9	17.4		50
55		22.2	26.3	29	28.6	28.5	26.8	25.6	23.3	21.7	19.2	16.6	14.1	13.8	13.4	55
60			20.8	24.1	23.9	24.1	22.6	21.5	19.5	18	15.7	13.5	10.9	10.7	10.3	60
65			16.6	19.8	20.1	20.4	19.1	18.2	16.3	15	12.7	10.7	8	7.8	7.3	65
70			13.1	16.2	17	17.4	16.1	15.3	13.5	12.3	10.3	8.3	4.9	4.8	4.4	70
75				13.3	14.1	14.8	13.6	12.9	11.2	10.1	8.1	5.6				75
80				10.9	11.6	12.5	11.5	10.8	9.1	8.1	5.6	3.4				80
85				8.9	9.5	10.5	9.5	8.9	7.3	6	3.6					85
90					7.7	8.7	7.9	7.3	5.3	4.1						90
95					6.1	7.1	6.4	5.6	3.4							95
100					4.7	5.6	4.7	3.8								100
105					3.7	3.9										105

t_240_001_00308_00_000

Lifting capacities Forces de levage

T



	48 ft	64 ft	80 ft	96 ft	112 ft	128 ft	144 ft	160 ft	176 ft	192 ft	208 ft	224 ft	
10	298.6												10
11	298.6	298.6											11
12	298.6	298.6	298.6										12
13	298.6	298.6	288.7										13
14	293.3	295.3	270.6										14
15	279	273.2	239.5	204.3	171								15
16	261.1	241.7	210.3	188.3	162.3								16
17	239.2	211.8	191.5	171.4	154.9								17
18	211.4	189.7	175.5	158.5	141.4								18
19	186.3	169.2	158.7	143.4	129	114.8							19
20	164.5	154.4	144.1	131.6	118.9	110							20
22	132	128.4	120.6	111.6	104.6	97.8	81.2						22
24	108.9	108.1	103.4	96.4	93.3	85.8	79.4						24
26	91.5	92.6	90.1	87.9	82.3	76	71.9	65.4					26
28	78	80.2	79.1	77.7	72.7	69.5	65	60.2					28
30	65.7	69.3	69.1	68.3	64.9	62.2	57.8	54	45.2				30
32	55.7	59.8	60.4	60.9	57.8	55.7	51.8	48.6	44.6				32
34	47.6	52	53.4	54.1	51.8	50.1	46.8	43.8	40.1	34.5			34
36	40.6	45.6	47.4	48.3	46.7	45.3	42.4	39.7	36.4	33.7			36
38	34.3	40.3	42.3	43.7	42.3	41.1	38.5	36.2	33.1	30.6	26.6		38
40	28.8	35.7	37.8	39.5	38.3	37.5	35.1	33	30.1	27.8	24.7		40
45		26.6	29	31	30.4	30	28.1	26.5	24	22.1	19.3	16.7	45
50		19.1	22.5	24.8	24.4	24.4	22.8	21.4	19.2	17.5	15.1	12.7	50
55		13.6	17.6	19.9	19.7	19.9	18.5	17.4	15.3	13.9	11.6	9	55
60			13.2	16	15.9	16.3	15	14.1	12.3	10.9	8.4	5.5	60
65			9.7	12.8	12.8	13.3	12.1	11.3	9.5	8.1	5.1		65
70			6.9	10.1	10.3	10.8	9.7	8.9	6.8	5.3			70
75				7.7	8	8.6	7.4	6.5	4.3				75
80				5.2	5.7	6.5	5	4.3					80
85					3.6	4.3							85

t_240_001_00309_00_000

Lifting heights Hauteurs de levage

T

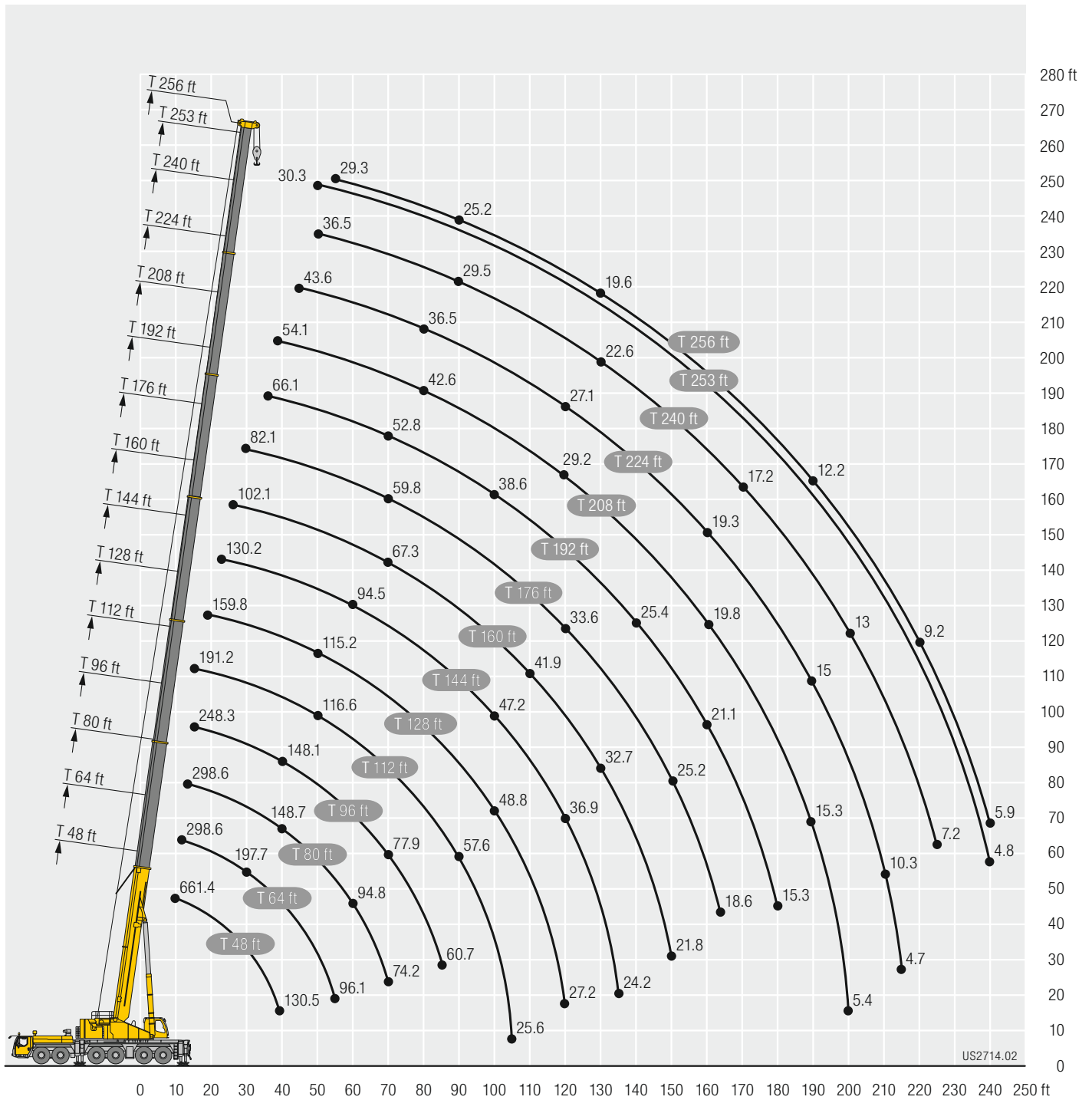

US2714.02

Lifting capacities Forces de levage

TK



	48 ft			64 ft			80 ft			96 ft			112 ft			128 ft			144 ft			160 ft			
	18 ft			18 ft			18 ft			18 ft			18 ft			18 ft			18 ft			18 ft			
	0°	20°	40°	0°	20°	40°	0°	20°	40°	0°	20°	40°	0°	20°	40°	0°	20°	40°	0°	20°	40°	0°	20°	40°	
12	128.3	101.2																						12	
13	125.9	99.2	84.3	130.9	103																			13	
14	122.7	97.2	82.9	130.3	101.1		130.4																	14	
15	119.5	95.3	81.7	127.6	99.4	83.9	129.2	100.7																15	
16	116.3	93.5	80.5	124.9	97.8	82.8	127.4	99.6		126.8														16	
17	113.7	91.8	79.3	122.4	96.2	81.8	125.2	98.2		125.1														17	
18	111.2	90.1	78.2	120	94.7	80.8	123.1	96.8	81.8	123.4	97.5		121.2											18	
19	108.6	88.4	77.1	117.6	93.3	79.9	121	95.5	81	121.7	96.4		119.9											19	
20	106	86.9	76.1	115.2	91.9	78.9	119	94.2	80.2	120	95.3		118.6											20	
22	101.2	84	74	110.7	89.2	77.1	115.1	91.7	78.5	116.6	93	79.4	115.9	93.5		105.6								22	
24	96.9	81.1	72.2	106.7	86.4	75.3	111.2	89.2	77	113.1	90.8	77.9	113.1	91.5	78.3	105.6	91.1							24	
26	92.9	78.6	70.4	102.6	84.1	73.6	107.5	87	75.4	109.9	88.7	76.5	110.2	89.5	77	105.3	89.6		95.2					26	
28	89.1	76.1	68.8	98.8	81.8	72.2	104.2	84.8	74.1	106.9	86.7	75.2	107.5	87.6	75.8	104.7	88.2	76.8	94.7	83.6				28	
30	86	73.8	67.3	95.4	79.5	70.8	101.1	82.8	72.7	103.9	84.8	73.9	104.8	85.8	74.6	103.9	86.9	75.8	94.2	82.7		79.4		30	
32	82.8	71.9	65.9	92.3	77.5	69.4	98	81	71.4	100.9	83	72.8	102.4	84.2	73.5	102.4	85.6	74.8	93.4	81.7	73	79.4		32	
34	79.9	70.1	64.7	89.2	75.6	68.2	95.1	79.2	70.2	98.5	81.2	71.6	100.1	82.6	72.4	100.8	84.3	73.9	92.4	80.7	72.2	79.3	73.9	34	
36	77.4	68.3	63.6	86.5	73.8	67	92.4	77.5	69.1	96.1	79.6	70.5	97.8	81.1	71.4	99.1	83.1	73	91.5	79.8	71.4	79	73.3	67.7	36
38	74.9	66.7	62.6	84.1	72.1	65.9	89.9	75.9	68	93.7	78.2	69.5	95.6	79.7	70.5	97.4	81.8	72.2	90.4	78.8	70.7	78.6	72.7	67.2	38
40	72.6	65.2	61.7	81.7	70.7	64.9	87.6	74.3	67	91.4	76.8	68.5	93.6	78.2	69.5	95.7	80.6	71.3	89.3	77.9	69.9	78.2	72	66.6	40
45	67.9	62.2	60.1	76.3	67.2	62.7	82.3	70.8	64.8	86.3	73.3	66.3	88.9	75.2	67.4	91.6	77.6	69.4	86.3	75.4	68.2	76.5	70.2	65.2	45
50	64.1	59.9	59.4	71.7	64.3	60.9	77.7	67.9	62.9	81.8	70.4	64.3	84.4	72.3	65.5	88	75	67.5	83.1	73.2	66.6	73.6	67.9	63.7	50
55	60.5	58.2	9.1	68	61.9	59.7	73.7	65.2	61.2	78	67.8	62.6	80.7	69.7	63.7	84.3	72.5	66	78.7	71	65.1	69.8	65.1	61.7	55
60				64.7	59.9	32.6	70.2	63	59.9	74.4	65.6	61.2	77.2	67.3	62.2	81.2	70.2	64.4	73.8	69	63.8	66.1	62.3	59.3	60
65				62.2	58.8	16	67.2	61.1	58.9	71.2	63.4	59.9	74.2	65.3	60.9	78.2	68.3	63.1	69.1	66.9	62.6	62.5	59.9	57.1	65
70				59.3	57.5	9.5	64.5	59.6	47.6	68.4	61.7	59	71.4	63.5	59.8	74.8	66.5	61.9	64.9	64.3	61	59	57.5	55.1	70
75				41.9			62.3	58.4	22.2	65.9	60.1	58.1	68.9	61.7	58.8	68.5	64.9	60.9	60.9	60.6	58.8	55.6	55.1	53.1	75
80							60.5	57.8	13.8	63.9	58.9	57.8	64.2	60.4	58	62.6	63	60.1	57.1	56.9	56.4	52.7	52.5	51.1	80
85							58.2	55.9	9.2	60.2	57.8	29	59	59	57.4	57.3	57.9	58	53.7	53.6	53.6	49.8	49.8	49	85
90							40.8	13.5		55.6	55.9	18.1	54.4	54.8	55	52.7	53.3	53.5	51.4	50.4	50.5	47.2	47.2	46.9	90
95										51.5	51.8	12.5	50.2	50.6	37.1	48.6	49.1	49.3	49.3	47.1	47.4	44.9	44.8	44.8	95
100										47.9	44.9	9	46.6	46.9	22.6	44.9	45.3	45.5	46.2	45.1	44.3	42.6	42.6	42.6	100
105										35.8	15.6	5.7	43.3	43.5	15.8	43.1	41.9	40.7	42.9	43.1	42.9	40.3	40.4	40.5	105
110													40.3	40.5	11.7	41.4	40.2	27.7	39.9	40.2	40.4	38.2	38.2	38.3	110
115													37.6	37.7	8.9	38.9	39	19.2	37.1	37.4	37.6	35.5	35.9	36.1	115
120													31	17	6.3	36.4	36.6	14.4	34.6	34.9	32.4	33	33.3	33.5	120
125																34.1	34.3	11.2	32.3	32.5	22.8	31.3	31.4	31.5	125
130																32	32.1	8.8	30.2	30.4	17.2	29.5	29.8	29.9	130
135																25	18.2	6.6	28.2	28.3	13.5	27.5	27.7	26.7	135
140																			26.3	26.4	10.8	25.6	25.8	20.1	140
145																			24.6	24.7	8.7	23.8	24	15.8	145
150																			20.7	19	6.9	22.2	22.4	12.7	150
155																						20.7	20.9	10.5	155
160																						19.4	19.4	8.6	160
165																						16.4	16.4	7	165
170																						10.5	9.4		170

t_240_002_50001_00_000 / 52001_00_000 / 54001_00_000

Lifting capacities Forces de levage

TK



Lifting height (ft)	176 ft			192 ft			208 ft			224 ft			240 ft			253 ft			256 ft			Lifting height (ft)				
	18 ft			18 ft			18 ft			18 ft			18 ft			18 ft			18 ft							
	0°	20°	40°	0°	20°	40°	0°	20°	40°	0°	20°	40°	0°	20°	40°	0°	20°	40°	0°	20°	40°	0°	20°	40°		
34	64.7																								34	
36	64.5																									36
38	64.2	64.7		51.5																						38
40	64	64.5		51.3																						40
45	63.2	63.7	61	50.8	51.2	51.4	41.6																			45
50	62.2	62.8	60	50.3	50.7	51.2	41.2	41.5	42.2	34			25.4													50
55	60.7	60.6	58.7	49.7	50	50.5	40.9	41.2	41.3	33.8	33.8	34.1	25.3	25.4		21						20.4				55
60	57.9	57.8	56.7	48.7	48.8	49	40.3	40.1	40.2	33.2	33.2	33.5	25.1	25.2	25.1	21	21					20.4	20.4			60
65	55	54.9	54.4	46.9	47	47.2	39.1	38.9	39	32.5	32.4	32.6	24.9	24.9	25	20.9	20.9	20.9				20.3	20.4	20.3		65
70	52.2	52.2	52.1	44.9	45	45.3	37.9	37.7	37.7	31.6	31.4	31.5	24.6	24.5	24.6	20.7	20.7	20.8				20.2	20.3	20.3		70
75	49.6	49.5	49.7	43	43.1	43.3	36.6	36.4	36.3	30.6	30.3	30.4	24.1	24	24.1	20.4	20.3	20.4				20	20	20.1		75
80	46.9	47	47.1	41.1	41.1	41.4	35.3	35	34.9	29.5	29.3	29.3	23.5	23.4	23.5	19.9	19.9	19.9				19.6	19.6	19.6		80
85	44.4	44.4	44.6	39.2	39.2	39.5	34	33.7	33.6	28.5	28.3	28.3	22.8	22.8	22.8	19.4	19.3	19.4				19.1	19.1	19.1		85
90	42.1	42.1	42.3	37.3	37.4	37.6	32.7	32.4	32.3	27.5	27.3	27.3	22.2	22.1	22.2	18.8	18.7	18.8				18.6	18.5	18.5		90
95	39.8	40	40.1	35.5	35.6	35.8	31.4	31.2	31.1	26.6	26.3	26.3	21.5	21.4	21.5	18.2	18.1	18.2				18	17.9	18		95
100	37.7	37.8	38	33.8	33.9	34.1	30.1	30	29.9	25.6	25.4	25.4	20.9	20.7	20.8	17.6	17.5	17.6				17.4	17.4	17.4		100
105	35.9	35.9	36	32.1	32.2	32.5	28.9	28.8	28.8	24.7	24.5	24.5	20.2	20.1	20.1	17	16.9	17				16.8	16.8	16.8		105
110	34	34.2	34.3	30.6	30.6	30.9	27.6	27.6	27.6	23.7	23.6	23.6	19.5	19.4	19.5	16.5	16.4	16.4				16.3	16.2	16.3		110
115	32.2	32.4	32.5	29.1	29.2	29.4	26.3	26.4	26.5	22.9	22.7	22.7	18.9	18.8	18.8	15.9	15.8	15.9				15.8	15.7	15.7		115
120	30.6	30.7	30.8	27.7	27.8	28	25.1	25.2	25.3	22.1	21.9	21.9	18.2	18.1	18.2	15.4	15.3	15.4				15.3	15.2	15.2		120
125	29.1	29.2	29.3	26.3	26.5	26.6	24	24	24.2	21.3	21.2	21.2	17.6	17.5	17.6	14.8	14.8	14.8				14.7	14.7	14.7		125
130	27.7	27.7	27.9	25	25.2	25.3	22.9	23	23.1	20.5	20.4	20.4	17.1	17	17	14.3	14.3	14.3				14.3	14.2	14.2		130
135	25.8	26.1	26.3	23.8	23.9	24	21.8	22	22.1	19.7	19.6	19.7	16.5	16.4	16.5	13.8	13.8	13.8				13.8	13.7	13.8		135
140	23.9	24.2	24.4	22.7	22.8	22.9	20.8	20.9	21	19	18.9	19	15.9	15.9	15.9	13.4	13.4	13.4				13.3	13.3	13.3		140
145	22.9	22.9	23	21.5	21.7	21.8	19.8	19.9	20	18.2	18.2	18.3	15.4	15.4	15.4	12.9	12.9	12.9				12.9	12.8	12.9		145
150	21.9	21.9	22	20.5	20.6	20.7	18.9	19	19.1	17.5	17.5	17.6	15	14.9	14.9	12.5	12.5	12.5				12.4	12.4	12.4		150
155	20.6	20.8	18.2	19.2	19.5	19.6	17.9	18.1	18.2	16.7	16.8	16.9	14.5	14.4	14.5	12.1	12.1	12.1				12	12	12		155
160	19.2	19.3	14.7	17.8	18.1	18.1	17.1	17.2	17.3	16	16.1	16.2	14	14	14	11.7	11.7	11.7				11.7	11.6	11.7		160
165	17.8	18	12.2	17	17.1	17.1	16.2	16.3	16.4	15.3	15.4	15.4	13.6	13.5	13.6	11.3	11.3	11.3				11.3	11.3	11.3		165
170	16.6	16.7	10.2	16.3	16.3	16.4	15.4	15.6	15.6	14.6	14.6	14.7	13.1	13.1	13.1	10.9	10.9	11				10.9	10.9	10.9		170
175	15.5	15.6	8.6	15.7	15.7	13.9	14.5	14.7	14.7	13.8	13.9	14	12.7	12.7	12.7	10.6	10.6	10.6				10.6	10.6	10.6		175
180	13.1	13.2	7.1	14.8	14.9	11.8	13.5	13.5	13.6	13.2	13.3	13.3	12.3	12.3	12.3	10.2	10.2	10.2				10.2	10.2	10.2		180
185	9.3	9.1		13.8	13.9	10	12.9	12.9	13	12.6	12.7	12.7	11.9	11.9	11.9	9.8	9.8	9.9				9.7	9.8	9.8		185
190				12.8	12.9	8.6	12.4	12.5	12.5	11.4	11.4	11.5	11.5	11.5	11.6	9.5	9.5	9.5				9.2	9.3	9.3		190
195				10.7	10.7	7.2	11.9	12	11.4	10.9	11	11	11	11	11.1	9.1	9.1	9.2				8.8	8.8	8.9		195
200				7.7	7.7	5.1	11.4	11.4	9.9	9.4	9.7	9.8	10.5	10.6	10.6	8.8	8.8	8.9				8.3	8.4	8.4		200
205							9.8	9.9	8.5	7.5	7.9	7.8	10	10.1	10.1	8.5	8.5	8.5				7.9	7.9	8		205
210							8.8	8.8	7.3	5.7	6	6	9.5	9.6	9.6	8.1	8.2	8.2				7.5	7.5	7.5		210
215							5.7	5.8	4.2	4	4.3	4.2	8.8	8.9	8.9	7.8	7.9	7.9				7.1	7.1	7.1		215
220										2.4	2.6	2.3	8.1	8.2	8.2	7.5	7.6	7.6				6.7	6.7	6.7		220
225													7.4	7.5	7.5	7.2	7.2	7.3				6.3	6.3	6.3		225
230													6.9	6.9	6.9	6.9	7	7				5.9	5.9	6		230
235													6.4	6.4	6.4	6.5	6.5	6.5				5.6	5.6	5.6		235
240													4.6	4.8	4.3	5.9	6	6				5.2	5.2	5.2		240
245																5.3	5.3	5.3				4.9	4.8	4.8		245
250																4.4	4.6	4.3				4.4	4.4	4.4		250
255																	2.1					2.8	3	2.6		255

L_240_002_50001_00_000 / 52001_00_000 / 54001_00_000

Lifting capacities Forces de levage

TK



↙ ↘	48 ft			144 ft			160 ft			176 ft			192 ft			↙ ↘
	0°	20°	40°	0°	20°	40°	0°	20°	40°	0°	20°	40°	0°	20°	40°	
12	52.4															12
13	52.1															13
14	51.7															14
15	51.2															15
16	50.7															16
17	50.1															17
18	49.5															18
19	48.9	39.2														19
20	48.3	39														20
22	47.1	37.2														22
24	45.8	35.3		52.7												24
26	44.3	33.6		52.8												26
28	42.9	32.1	23.1	52.8			47.4									28
30	41.4	30.8	22.8	52.6			47.4									30
32	40.1	29.5	22.1	52.4			47.4			41.7						32
34	38.8	28.5	21.6	52			47.3			41.6						34
36	37.5	27.4	21.1	51.6			47.1			41.6			35.6			36
38	36.3	26.4	20.6	51.2	38.4		46.7			41.5			35.7			38
40	34.9	25.6	20.2	50.7	37.5		46.3			41.3			35.7			40
45	31.2	23.6	19.2	49.3	35.2	23.1	45.4	36.1		40.7			35.5			45
50	28	22.1	18.4	47.8	33.3	22.3	44.5	34.1	22.5	40.1	34.5		35.2			50
55	25.4	20.8	17.8	46.3	31.6	21.7	43.5	32.3	21.9	39.5	32.9	22	34.8	31.8		55
60	23.4	19.6	17.4	44.6	30	21.1	42.6	30.8	21.3	38.8	31.3	21.4	34.4	31	21.5	60
65	21.6	18.7	17.1	42.8	28.7	20.6	41.4	29.5	20.8	38.2	29.9	20.9	34	30.1	20.9	65
70	20.1	18	17.1	41.1	27.5	20.1	40.1	28.3	20.3	37.5	28.7	20.5	33.6	28.8	20.5	70
75	18.8	17.6	16.3	39.5	26.4	19.6	38.8	27.2	19.9	36.7	27.5	20	33.1	27.7	20.1	75
80	17.8	17.5		38	25.4	19.2	37.6	26.2	19.5	35.8	26.6	19.7	32.7	26.7	19.7	80
85				36.5	24.5	18.9	36.4	25.2	19.1	34.9	25.7	19.3	32	25.8	19.4	85
90				34.8	23.6	18.6	35.2	24.4	18.8	34	24.8	19	31.4	25	19.1	90
95				33	22.9	18.3	34.1	23.6	18.5	33.1	24	18.7	30.7	24.3	18.8	95
100				31.3	22.2	18	32.9	22.9	18.2	32.3	23.3	18.4	29.9	23.5	18.5	100
105				29.6	21.5	17.8	31.4	22.3	18	31.5	22.7	18.1	29	22.9	18.2	105
110				28.2	20.9	17.6	30	21.6	17.8	30.5	22.1	17.9	27.8	22.3	18	110
115				26.9	20.4	17.4	28.6	21	17.6	29.4	21.5	17.7	26.5	21.7	17.8	115
120				25.7	19.9	17.3	27.3	20.6	17.4	28.2	21	17.5	25.4	21.1	17.6	120
125				24.6	19.4	17.2	26.3	20.1	17.3	27	20.5	17.4	24.3	20.7	17.4	125
130				23.7	19	17.1	25.2	19.6	17.1	25.9	20.1	17.2	23.2	20.3	17.3	130
135				22.8	18.6	17.1	24.2	19.2	17.1	24.7	19.7	17.2	22.2	19.9	17.2	135
140				21.9	18.3	17.1	23.3	18.9	17	23.6	19.3	17.1	21.2	19.5	17.1	140
145				21.1	18	15.7	22.6	18.6	17	22.6	18.9	17	20.2	19.1	17.1	145
150				20.4	17.8	10.1	21.8	18.2	17	21.5	18.6	17	19.3	18.7	17	150
155				19.7	17.6	7.2	21	18	16.5	20.4	18.4	17	18.4	18.3	17	155
160				19.1	17.5	5.4	20.4	17.8	12.4	19	18.1	17	17.5	17.8	16.8	160
165				18.6	17.5		19.4	17.6	8.7	17.7	17.8	17	16.7	17.1	16.6	165
170				17.2	16		18.1	17.5	6.6	17	17.1	15.1	16	16.4	16.4	170
175				10.2	6.9		17	17.4	5.1	16.3	16.5	10.5	15	15.6	15.8	175
180							15.9	16.3		15.5	15.8	7.8	14	14.7	15	180
185							13.3	15.2		14.5	15	6.1	13.1	13.6	12.2	185
190							7.7	7.5		13.6	14	4.9	12.6	12.7	9.1	190
195										12.7	13		12.1	12.2	7.2	195
200										10.4	12.1		11.6	11.7	5.8	200
205										6.1	7.8		11	11.3		205
210													10.3	10.6		210
215													8.3	9.8		215
220													7.1	7.2		220

t_240_002_50101_00_000 / 52101_00_000 / 54101_00_000

Lifting capacities Forces de levage

TK



41 ft 41 ft	208 ft			224 ft			240 ft			253 ft			256 ft			41 ft 41 ft
	0°	20°	40°	0°	20°	40°	0°	20°	40°	0°	20°	40°	0°	20°	40°	
45	30			23.3												45
50	30.1			23.5			19.4									50
55	29.9			23.6			19.4			16.4			15.9			55
60	29.7	28.3		23.8			19.4			16.4			15.9			60
65	29.5	27.8	20.9	23.9	23.9		19.3			16.4			16			65
70	29.3	27.3	22.6	23.8	23.7		19.2	19.2		16.3			15.9			70
75	28.9	26.9	22	23.6	23.3	22.5	19.1	18.8		16.1	16		15.8	15.7		75
80	28.5	26.4	21.5	23.2	22.8	22.1	18.9	18.4	17.8	15.9	15.8		15.6	15.5		80
85	28.1	25.6	21.1	22.6	22.3	21.6	18.7	17.9	17.4	15.7	15.5	15.1	15.4	15.2	15	85
90	27.4	24.8	20.8	22.1	21.7	21.2	18.2	17.5	16.9	15.5	15.1	14.7	15.2	15	14.6	90
95	26.7	24.1	20.5	21.5	21.1	20.7	17.9	17	16.4	15.1	14.8	14.4	14.9	14.6	14.2	95
100	25.8	23.4	20.2	20.8	20.4	20.3	17.4	16.6	16	14.7	14.4	14	14.5	14.3	13.9	100
105	24.9	22.8	19.9	20.2	19.8	19.7	17	16.1	15.6	14.3	14.1	13.7	14.1	13.9	13.6	105
110	24	22.2	19.4	19.5	19.1	19.1	16.5	15.7	15.2	13.9	13.7	13.4	13.8	13.6	13.3	110
115	23.2	21.7	18.8	18.9	18.5	18.5	16.1	15.3	14.9	13.5	13.3	13	13.4	13.2	12.9	115
120	22.4	21.1	18.2	18.2	17.9	17.9	15.6	14.9	14.5	13.1	12.9	12.7	12.9	12.8	12.6	120
125	21.5	20.7	17.6	17.6	17.3	17.3	15.1	14.6	14.2	12.6	12.5	12.4	12.5	12.4	12.3	125
130	20.7	20.1	17.3	17	16.8	16.7	14.6	4.2	13.9	12.2	12.1	12.1	12.1	12	12.1	130
135	19.9	19.6	17.2	16.4	16.2	16.2	14.1	13.8	13.5	11.8	11.7	11.8	11.7	11.6	11.7	135
140	19.1	19	17.1	15.9	15.7	15.7	13.7	13.4	13.2	11.4	11.3	11.4	11.3	11.2	11.4	140
145	18.3	18.3	17.1	15.4	15.2	15.2	13.2	13	12.9	11	10.9	11	10.9	10.9	11	145
150	17.5	17.7	17	14.9	14.7	14.7	12.8	12.7	12.6	10.6	10.6	10.7	10.6	10.5	10.6	150
155	16.7	17.1	16.8	14.4	14.3	14.3	12.4	12.3	12.3	10.3	10.2	10.3	10.2	10.2	10.3	155
160	16	16.4	16.3	13.9	13.8	13.8	12	11.9	12	9.9	9.9	10	9.8	9.8	9.9	160
165	15.3	15.6	15.7	13.5	13.3	13.4	11.6	11.6	11.6	9.6	9.5	9.6	9.5	9.5	9.6	165
170	14.6	14.9	15.2	13	12.9	13	11.2	11.2	11.3	9.2	9.2	9.3	9.2	9.2	9.3	170
175	13.9	14.2	14.5	12.5	12.5	12.6	10.9	10.8	10.9	8.9	8.9	9	8.9	8.9	9	175
180	13.2	13.6	13.9	12.1	12.1	12.2	10.5	10.5	10.6	8.6	8.6	8.7	8.6	8.6	8.7	180
185	12.6	13	13.2	11.6	11.7	11.8	10.2	10.2	10.3	8.3	8.3	8.4	8.3	8.3	8.4	185
190	12	12.3	12.6	11.1	11.3	11.5	9.8	9.8	9.9	8	8	8.1	8	8	8.1	190
195	11.2	11.7	11.9	10.7	10.9	11.1	9.5	9.5	9.6	7.8	7.8	7.9	7.7	7.8	7.9	195
200	10.3	11	10.7	10.2	10.4	10.7	9.2	9.2	9.3	7.5	7.5	7.6	7.4	7.5	7.6	200
205	9.8	10.1	8.3	9.7	10	10.2	8.9	8.9	9	7.3	7.3	7.4	7.1	7.3	7.4	205
210	9.5	9.5	6.7	9.2	9.5	9.7	8.6	8.7	8.8	7.1	7	7.1	6.8	7.1	7.1	210
215	9.1	9.2	5.5	8.7	9	9.2	8.3	8.4	8.5	6.8	6.8	6.9	6.5	6.8	6.8	215
220	8.7	8.8		7.9	8.4	7.6	7.9	8.1	8.2	6.6	6.6	6.7	6.2	6.4	6.5	220
225	8.4	8.5		7.6	7.7	6.3	7.6	7.8	7.9	6.4	6.4	6.5	5.9	6.1	6.2	225
230	7	8.2		7.4	7.4	5.3	7.2	7.5	7.6	6.2	6.2	6.3	5.5	5.7	5.9	230
235	5.6	6.6		7.1	7.2		6.8	7.1	7	6	6	6.1	5.1	5.4	5.5	235
240				6.9	6.9		6.3	6.6	6	5.8	5.8	5.9	4.8	5	5.1	240
245				6.1	6.8		5.8	6.1	5.1	5.5	5.6	5.7	4.4	4.7	4.7	245
250				3.5	4.8		5.1	5.5		5.2	5.4	5.5	4.1	4.3	4.4	250
255							4.6	4.9		4.6	5	5.1	3.8	4	4	255
260							3.2	4.3		4	4.4		3.5	3.7	3.7	260
265										3.4	3.8		3.2	3.4		265
270										2.8	3.2		2.7	3		270
275														2.4		275

t_240_002_50101_00_000 / 52101_00_000 / 54101_00_000

Lifting capacities Forces de levage

TK



↙ ↘	48 ft 69 ft			144 ft 69 ft			160 ft 69 ft			176 ft 69 ft			192 ft 69 ft			↙ ↘
	0°	20°	40°	0°	20°	40°	0°	20°	40°	0°	20°	40°	0°	20°	40°	
12	20.8															12
13	20.8															13
14	20.9															14
15	21															15
16	21															16
17	21															17
18	21															18
19	21															19
20	21															20
22	21															22
24	20.9															24
26	20.7															26
28	20.5			20.8												28
30	20.3			20.9			19.9									30
32	20			21			19.9									32
34	19.7	17.8		21			19.9			18.7						34
36	19.4	17.5		21			19.9			18.7						36
38	19.1	17.2		21			19.9			18.8			17.4			38
40	18.7	16.9		21			19.9			18.8			17.4			40
45	17.9	16.1		21			19.9			18.8			17.5			45
50	17.1	15.4		20.8			19.9			18.8			17.5			50
55	16.3	14.7	13.2	20.5	17.5		19.8	17.2		18.8			17.5			55
60	15.5	14.1	12.8	20.3	17		19.6	16.8		18.7	16.3		17.5			60
65	14.8	13.6	12.4	19.9	16.7		19.3	16.4		18.5	16		17.3	15.2		65
70	14.2	13.1	12	19.5	16.2	13.4	19	16		18.2	15.6		17.1	15		70
75	13.6	12.6	11.8	19	15.8	13.2	18.6	15.6	13.1	17.9	15.3		16.8	14.7		75
80	13.1	12.3	11.6	18.6	15.4	13	18.2	15.3	12.9	17.6	15	12.7	16.6	14.4		80
85	12.6	12	11.4	18.1	15.1	12.8	17.8	15	12.7	17.2	14.7	12.5	16.3	14.2	12.2	85
90	12.1	11.7	11.4	17.7	14.7	12.6	17.4	14.6	12.5	16.9	14.4	12.3	16	13.9	12.1	90
95	11.6	11.5	11.4	17.2	14.4	12.4	17	14.3	12.3	16.5	14.1	12.2	15.7	13.7	11.9	95
100	11.1	11.4	11.4	16.7	14.1	12.2	16.6	14.1	12.2	16.2	13.9	12	15.4	13.4	11.8	100
105	10.6	11.3	4.5	16.3	13.8	12.1	16.2	13.8	12	15.8	13.6	11.9	15.1	13.2	11.7	105
110	9.8			15.9	13.5	11.9	15.8	13.5	11.9	15.5	13.4	11.7	14.9	13	11.5	110
115				15.5	13.3	11.8	15.5	13.3	11.8	15.2	13.1	11.6	14.6	12.8	11.4	115
120				15.1	13.1	11.7	15.1	13	11.6	14.9	12.9	11.5	14.4	12.6	11.3	120
125				14.7	12.8	11.6	14.8	12.8	11.5	14.6	12.7	11.4	14.1	12.4	11.2	125
130				14.4	12.6	11.5	14.4	12.6	11.4	14.3	12.5	11.4	13.9	12.3	11.1	130
135				14.1	12.4	11.4	14.1	12.4	11.4	14	12.3	11.3	13.6	12.1	11.1	135
140				13.7	12.2	11.4	13.8	12.3	11.3	13.8	12.2	11.2	13.4	11.9	11	140
145				13.4	12.1	11.4	13.6	12.1	11.3	13.5	12	11.2	13.2	11.8	11	145
150				13.1	11.9	11.4	13.3	11.9	11.2	13.2	11.9	11.1	13	11.7	10.9	150
155				12.9	11.8	11.4	13	11.8	11.2	13	11.7	11.1	12.8	11.5	10.9	155
160				12.6	11.7	11.4	12.8	11.7	11.2	12.8	11.6	11.1	12.6	11.4	10.8	160
165				12.3	11.6	11.4	12.5	11.6	11.2	12.5	11.5	11.1	12.4	11.3	10.8	165
170				12	11.5	11.4	12.3	11.5	11.2	12.3	11.4	11.1	12.2	11.2	10.8	170
175				11.8	11.5	11.4	12.1	11.4	11.2	12.1	11.3	11.1	12	11.1	10.8	175
180				11.5	11.4	8.6	11.8	11.3	11.2	12	11.2	11.1	11.8	11.1	10.8	180
185				11.2	11.3	6.2	11.6	11.3	11.2	11.8	11.2	11.1	11.7	11	10.8	185
190				10.9	11.3		11.4	11.3	10.3	11.6	11.1	11.1	11.5	10.9	10.8	190
195				10.6	11.3		11.2	11.2	7.6	11.4	11.1	11.1	11.2	10.9	10.8	195
200				10.2	10.7		11	11.2	5.8	11.3	11.1	11.1	11	10.9	10.8	200
205							10.8	11.2		11.1	11	9.1	10.7	10.9	10.8	205
210							10.5	11.2		10.9	11	7	10.1	10.6	10.8	210
215							7.7	10.6		10.7	10.9	5.4	9.4	10.2	10.3	215
220										10.1	10.7		9	9.4	8.2	220
225										8.8	9.9		8.7	8.8	6.4	225
230										6	8.1		8.3	8.5	5.2	230
235											3		8	8.2		235
240													7	7.9		240
245													5.2	6.5		245
250														5.2		250

t_240_002_50301_00_000 / 52301_00_000 / 54301_00_000

Lifting capacities Forces de levage

TK



48-256 ft T	208 ft 69 ft			224 ft 69 ft			240 ft 69 ft			253 ft 69 ft			256 ft 69 ft			48-256 ft T
	0°	20°	40°	0°	20°	40°	0°	20°	40°	0°	20°	40°	0°	20°	40°	
45	15.8															45
50	15.9			14												50
55	15.9			14.1			12.2									55
60	15.8			14.1			12.2			10.6			10.4			60
65	15.7			14			12.2			10.6			10.4			65
70	15.6	14.1		14			12.2			10.7			10.4			70
75	15.5	13.9		13.8			12.1			10.7			10.5			75
80	15.2	13.6		13.7	12.6		12.1			10.7			10.4			80
85	15	13.4		13.6	12.5		12	11.3		10.6			10.4			85
90	14.8	13.2	11.7	13.4	12.3		11.9	11.2		10.6	10.2		10.4	10		90
95	14.6	13	11.5	13.2	12.1	11.1	11.8	11.1		10.5	10.1		10.3	9.9		95
100	14.4	12.8	11.4	13.1	12	11	11.7	11		10.4	10.1		10.3	9.9		100
105	14.2	12.6	11.3	13	11.9	10.9	11.6	10.9	10.3	10.4	10		10.2	9.8		105
110	14	12.4	11.2	12.8	11.7	10.8	11.5	10.8	10.3	10.3	9.9	9.6	10.1	9.8	9.5	110
115	13.8	12.3	11.1	12.7	11.6	10.7	11.4	10.7	10.2	10.2	9.8	9.5	10	9.7	9.4	115
120	13.6	12.1	11	12.5	11.5	10.6	11.2	10.6	10.1	10.1	9.6	9.4	10	9.5	9.3	120
125	13.4	12	11	12.4	11.4	10.6	11.1	10.5	10.1	10	9.4	9.2	9.9	9.4	9.1	125
130	13.2	11.8	10.9	12.2	11.2	10.5	10.9	10.4	10	9.8	9.2	8.9	9.7	9.1	8.9	130
135	13	11.7	10.8	12.1	11.1	10.5	10.8	10.2	9.9	9.5	9	8.7	9.4	8.9	8.7	135
140	12.8	11.5	10.8	11.9	11	10.5	10.6	10	9.7	9.2	8.7	8.5	9.2	8.7	8.5	140
145	12.6	11.4	10.7	11.8	10.9	10.4	10.4	9.8	9.5	9	8.5	8.3	8.9	8.5	8.3	145
150	12.4	11.3	10.7	11.6	10.8	10.4	10.2	9.5	9.3	8.7	8.3	8.1	8.7	8.3	8.1	150
155	12.2	11.2	10.7	11.5	10.7	10.4	10	9.3	9.1	8.5	8.1	7.9	8.4	8.1	7.9	155
160	12.1	11.1	10.6	11.3	10.6	10.3	9.7	9.1	8.9	8.2	7.9	7.8	8.2	7.9	7.8	160
165	11.9	11	10.6	11.1	10.5	10.3	9.5	8.9	8.8	8	7.7	7.6	7.9	7.7	7.6	165
170	11.8	10.9	10.6	10.8	10.4	10.3	9.2	8.7	8.6	7.7	7.6	7.5	7.7	7.5	7.5	170
175	11.6	10.9	10.6	10.5	10.2	10.3	8.9	8.5	8.4	7.4	7.4	7.3	7.4	7.4	7.3	175
180	11.4	10.8	10.6	10.2	10	10.2	8.7	8.3	8.2	7.2	7.2	7.2	7.2	7.2	7.2	180
185	11.1	10.7	10.6	9.9	9.8	10	8.5	8.1	8.1	7	7	7	6.9	7	7	185
190	10.8	10.7	10.6	9.6	9.6	9.8	8.2	8	7.9	6.8	6.8	6.9	6.7	6.8	6.9	190
195	10.6	10.6	10.6	9.3	9.3	9.6	7.9	7.8	7.8	6.6	6.7	6.8	6.5	6.6	6.7	195
200	10.3	10.5	10.6	9.1	9.1	9.3	7.7	7.6	7.6	6.4	6.5	6.6	6.3	6.4	6.6	200
205	9.9	10.2	10.5	8.8	8.8	9	7.5	7.5	7.5	6.2	6.3	6.4	6.2	6.2	6.4	205
210	9.5	9.8	10.2	8.5	8.5	8.7	7.3	7.3	7.4	6	6.1	6.2	6	6	6.2	210
215	9.1	9.5	9.9	8.2	8.3	8.5	7.1	7.1	7.2	5.8	5.9	6	5.8	5.9	6	215
220	8.6	9.1	9.4	7.9	8	8.2	6.9	6.9	7.1	5.6	5.7	5.9	5.6	5.7	5.8	220
225	7.9	8.7	8.9	7.6	7.7	8	6.7	6.8	6.9	5.5	5.5	5.7	5.3	5.5	5.7	225
230	7.3	8.1	8.4	7.3	7.5	7.7	6.5	6.6	6.8	5.3	5.4	5.5	5	5.3	5.5	230
235	7	7.5	7.5	6.9	7.2	7.4	6.3	6.4	6.6	5.1	5.2	5.4	4.7	5.2	5.3	235
240	6.8	7	6.1	6.5	6.9	7.1	6.1	6.3	6.4	5	5	5.2	4.5	5	5.1	240
245	6.6	6.7	5	6.1	6.6	6.8	5.9	6.1	6.2	4.8	4.9	5	4.2	4.7	4.8	245
250	6.4	6.5		5.7	6.2	6.3	5.7	5.9	6.1	4.6	4.7	4.9	3.9	4.4	4.5	250
255	5.7	6.2		5.5	5.7	5.7	5.4	5.7	5.9	4.4	4.6	4.7	3.6	4.1	4.2	255
260	4.9	5.4		5.4	5.4		4.9	5.4	5.6	4.2	4.4	4.5	3.3	3.7	3.9	260
265		3.4		5.2	5.3		4.4	5.1	5.3	4	4.2	4.4	3	3.4	3.5	265
270				4.7	5.1		3.9	4.5	4.6	3.7	4	4.1	2.7	3.1	3.2	270
275				2.8	4.5		3.3	3.9		3.3	3.8	3.9	2.4	2.8	2.9	275
280							2.8	3.4		2.5	3.4	3.5		2.5	2.5	280
285								2.8				2.9				285

t_240_002_50301_00_000 / 52301_00_000 / 54301_00_000

Lifting heights Hauteurs de levage

TK

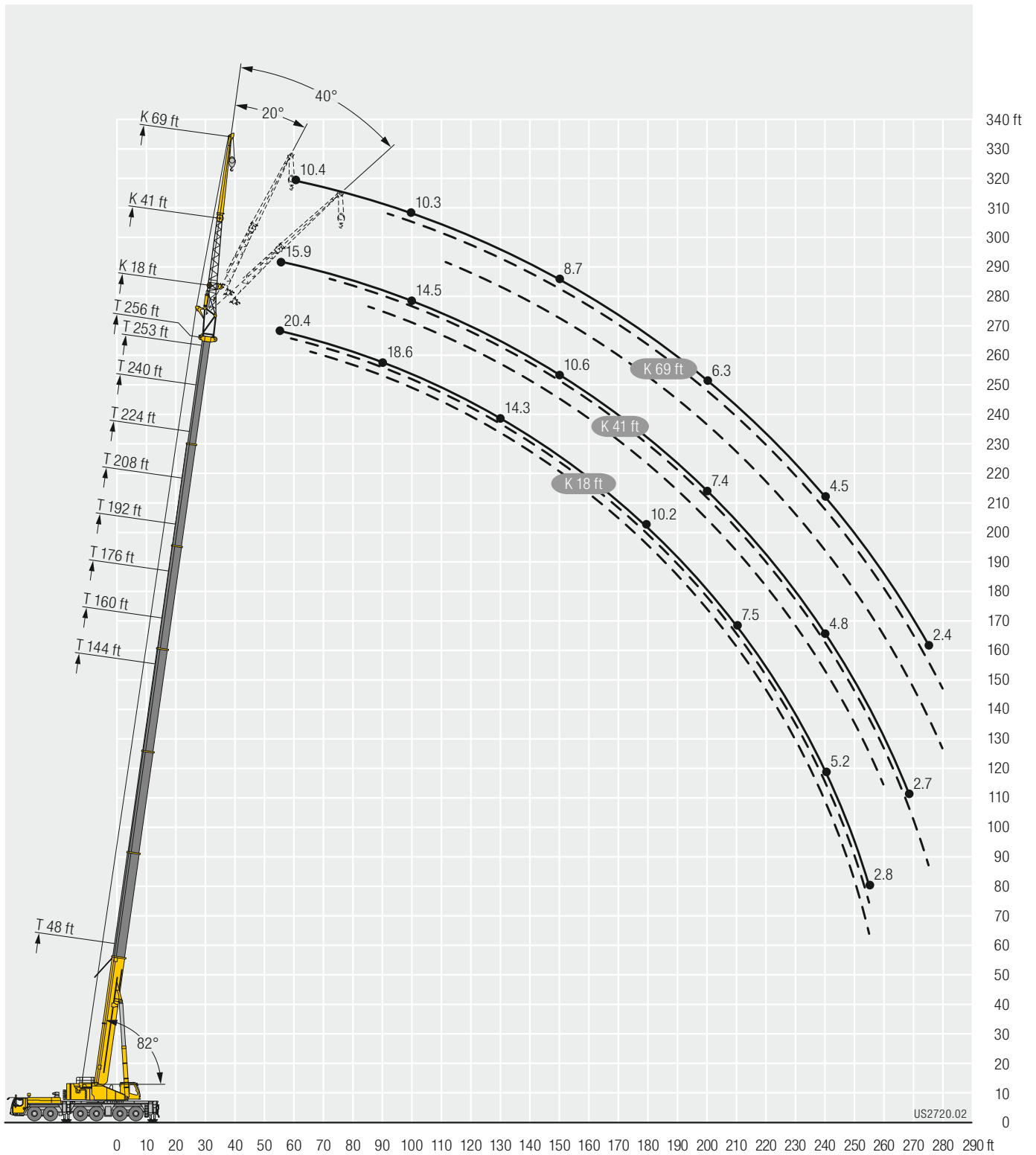

Lifting capacities

Forces de levage

TK



Height (ft)	48 ft			144 ft			160 ft			176 ft			192 ft			Height (ft)	
	0°	20°	40°	0°	20°	40°	0°	20°	40°	0°	20°	40°	0°	20°	40°		
12	31.4															12	
13	31.4															13	
14	31.4															14	
15	31.4															15	
16	31.2															16	
17	31															17	
18	30.7															18	
19	30.5															19	
20	30.2															20	
22	29.6															22	
24	29															24	
26	28.4															26	
27.7				31.4												28	
30	27.1			31.4			27									30	
32	26.4	22.9		31.4			27									32	
34	25.8	22.3		31.3			27					24.9				34	
36	25.2	21.6		31.1			27					24.9				36	
38	24.6	21		30.9			27					24.9		22.1		38	
40	24	20.4		30.6			27					25		22.1		40	
45	22.6	19.1		29.8			27					25		22.1		45	
50	21.2	17.9	15.1	29	22.7		26.9					25		22.2		50	
55	19.7	16.9	14.3	28.1	21.8		26.7	22.3				24.7		22.1		55	
60	18.2	16	13.7	27.3	21		26.1	21.7				24.3	20.9	21.9		60	
65	16.9	15.2	13.1	26.4	20.3	15.4	25.5	21.2				23.9	20.4	21.6	19.3	65	
70	15.6	14.5	12.6	25.6	19.6	15	25	20.6	15.9			23.4	19.9	21.3	18.9	70	
75	14.5	13.8	12.2	24.8	18.9	14.6	24.3	20.1	15.7			23	19.5	21	18.6	75	
80	13.6	13.2	11.9	24	18.3	14.3	23.7	19.6	15.4			22.5	19.1	20.7	18.2	14.9	80
85	12.7	12.7	11.7	23.2	17.8	14	23.1	19.1	15.1			22.1	18.7	20.4	17.9	14.6	85
90	11.9	12.2	11.6	22.4	17.2	13.7	22.5	18.6	14.8			21.6	18.2	20	17.5	14.4	90
95	11.3	11.8	11.6	21.7	16.7	13.4	21.9	18.1	14.5			21.1	17.8	19.7	17.2	14.2	95
100	10.7	11.6	5.1	20.9	16.2	13.1	21.4	17.6	14.3			20.7	17.4	19.4	16.8	14	100
105	10.3			20.1	15.8	12.9	20.8	17.1	14.1			20.2	17	19.1	16.5	13.8	105
110				19.3	15.4	12.7	20.3	16.7	13.9			19.8	16.6	18.8	16.2	13.6	110
115				18.5	15	12.5	19.8	16.3	13.7			19.4	16.2	18.4	15.9	13.4	115
120				17.7	14.7	12.3	19.3	15.9	13.5			18.9	15.9	18.1	15.5	13.2	120
125				17	14.3	12.1	18.8	15.6	13.3			18.5	15.6	17.8	15.2	13.1	125
130				16.3	14	12	18.3	15.3	13.2			18.1	15.2	17.5	15	13	130
135				15.6	13.7	11.9	17.8	14.9	13			17.7	15	17.2	14.7	12.8	135
140				15	13.4	11.8	17.3	14.6	12.9			17.3	14.7	16.8	14.4	12.8	140
145				14.5	13.1	11.7	16.9	14.3	12.8			16.9	14.4	16.5	14.2	12.7	145
150				14	12.9	11.7	16.4	14	12.8			16.5	14.1	16.2	14	12.6	150
155				13.5	12.6	11.6	15.9	13.8	12.7			16.1	13.9	15.8	13.7	12.5	155
160				13	12.3	11.6	15.4	13.5	12.6			15.7	13.6	15.5	13.5	12.5	160
165				12.5	12.1	11.6	14.9	13.3	12.6			15.3	13.3	15.1	13.3	12.4	165
170				12.1	12	11.6	14.4	13	12.6			14.9	13.1	14.7	13.1	12.4	170
175				11.8	11.8	8.6	13.9	12.8	12.6			14.5	12.9	14.2	12.9	12.3	175
180				11.4	11.7	6.3	13.5	12.6	12.6			14.1	12.7	13.8	12.7	12.3	180
185				11.1	11.6		13.1	12.5	10.6			13.7	12.5	13.3	12.5	12.3	185
190				10.8	11.6		12.7	12.3	7.6			13.3	12.4	12.7	12.2	12.3	190
195				10.5	11.1		12.3	12.3	5.8			12.8	12.3	12.2	12	12.3	195
200							12	12.2				12.4	12.2	11.3	11.8	12	200
205							11.5	12.2				11.9	11.9	10.5	11.4	11.6	205
210							8.2	10.9				11.2	11.5	9.7	10.6	10.6	210
215								3.8				10.5	11	9.4	9.7	8.2	215
220												9.3	10.2	9	9.2	6.5	220
225												6.3	8.4	8.7	8.8	5.2	225
230													3.4	8.3	8.5		230
235														7.4	8.1		235
240														5.4	6.8		240
245														4.1	5.4		245

t_240_002_50201_00_000 / 52201_00_000 / 54201_00_000

Lifting capacities Forces de levage

TK



↙ ↘	208 ft 64 ft			224 ft 64 ft			240 ft 64 ft			253 ft 64 ft			256 ft 64 ft			↙ ↘
	0°	20°	40°	0°	20°	40°	0°	20°	40°	0°	20°	40°	0°	20°	40°	
45	19.2															45
50	19.2			16.4												50
55	19.3			16.4			13.8									55
60	19.2			16.4			13.9			11.9			11.6			60
65	19.1			16.4			13.9			11.9			11.6			65
70	18.9	17.5		16.4			13.9			12			11.7			70
75	18.7	17.2		16.3	15.5		13.9			12			11.7			75
80	18.5	17		16.2	15.4		13.8			11.8			11.6			80
85	18.3	16.7	14.2	16	15.2		13.7	13.2		11.7			11.5			85
90	18.1	16.5	14	15.9	15.1		13.6	13.2		11.6	11.2		11.4	10.9		90
95	17.9	16.2	13.8	15.7	14.9	13.1	13.5	13.1		11.5	11.2		11.3	10.9		95
100	17.7	15.9	13.6	15.6	14.8	13	13.3	12.9	12.1	11.4	11.1		11.2	10.8		100
105	17.4	15.7	13.4	15.4	14.6	12.9	13.2	12.6	12	11.2	10.9	10.5	11.1	10.7	10.4	105
110	17.2	15.4	13.2	15.2	14.4	12.7	13	12.2	11.7	11.1	10.6	10.2	10.9	10.5	10.2	110
115	17	15.2	13.1	15	14.2	12.6	12.8	11.9	11.4	10.9	10.3	10	10.7	10.2	9.9	115
120	16.8	14.9	13	14.8	14	12.5	12.5	11.6	11.2	10.7	10.1	9.7	10.6	10	9.7	120
125	16.6	14.7	12.8	14.6	13.8	12.4	12.2	11.3	10.9	10.5	9.8	9.5	10.4	9.7	9.4	125
130	16.3	14.4	12.7	14.3	13.6	12.3	11.8	11	10.6	10.2	9.6	9.3	10.1	9.5	9.2	130
135	16.1	14.2	12.6	14	13.4	12.2	11.5	10.7	10.4	9.9	9.3	9	9.8	9.2	9	135
140	15.9	14	12.5	13.7	13.2	12.2	11.2	10.5	10.1	9.6	9.1	8.8	9.5	9	8.8	140
145	15.6	13.8	12.4	13.2	12.9	12.1	10.9	10.2	9.9	9.3	8.9	8.6	9.2	8.8	8.6	145
150	15.2	13.6	12.4	12.8	12.6	12	10.6	9.9	9.7	9	8.6	8.4	8.9	8.6	8.4	150
155	14.8	13.4	12.3	12.4	12.2	11.9	10.4	9.7	9.5	8.7	8.4	8.2	8.6	8.4	8.2	155
160	14.3	13.1	12.2	12	11.8	11.7	10.1	9.5	9.2	8.4	8.2	8	8.3	8.2	8	160
165	13.9	12.9	12.2	11.6	11.5	11.5	9.8	9.2	9	8.1	8	7.8	8.1	7.9	7.8	165
170	13.4	12.7	12.1	11.2	11.1	11.2	9.5	9	8.9	7.8	7.8	7.7	7.8	7.7	7.7	170
175	13	12.5	12.1	10.9	10.8	10.9	9.2	8.8	8.7	7.5	7.5	7.5	7.5	7.5	7.5	175
180	12.5	12.2	12	10.5	10.5	10.6	9	8.6	8.5	7.2	7.3	7.3	7.2	7.3	7.3	180
185	12	11.9	11.9	10.1	10.1	10.3	8.7	8.4	8.3	7	7.1	7.2	7	7.1	7.1	185
190	11.4	11.6	11.7	9.8	9.8	10	8.4	8.2	8.2	6.8	6.9	7	6.8	6.9	7	190
195	10.9	11.3	11.6	9.5	9.5	9.7	8.1	8	8	6.6	6.7	6.8	6.6	6.7	6.8	195
200	10.4	10.9	11.1	9.2	9.2	9.4	7.8	7.9	7.9	6.4	6.5	6.6	6.4	6.5	6.6	200
205	10	10.4	10.7	8.9	8.9	9.1	7.6	7.6	7.7	6.2	6.3	6.4	6.2	6.3	6.4	205
210	9.5	9.9	10.2	8.6	8.6	8.8	7.4	7.4	7.5	6	6.1	6.2	6	6.1	6.2	210
215	8.9	9.5	9.7	8.3	8.3	8.6	7.2	7.2	7.3	5.8	5.9	6	5.8	5.9	6	215
220	8.3	9	9.2	7.9	8	8.3	7	7	7.1	5.7	5.7	5.9	5.5	5.7	5.9	220
225	7.6	8.4	8.6	7.6	7.7	8	6.7	6.8	6.9	5.5	5.5	5.7	5.2	5.5	5.7	225
230	7.3	7.7	7.5	7.2	7.4	7.7	6.5	6.6	6.8	5.3	5.4	5.5	4.9	5.3	5.5	230
235	7	7.1	6.1	6.8	7.1	7.3	6.3	6.4	6.6	5.2	5.2	5.3	4.6	5.1	5.3	235
240	6.8	6.9	5	6.3	6.8	7	6.1	6.3	6.4	5	5	5.2	4.3	4.8	5	240
245	6.6	6.6		5.9	6.3	6.5	5.8	6.1	6.2	4.8	4.9	5	4.1	4.5	4.7	245
250	6	6.4		5.7	5.8	5.8	5.6	5.9	6.1	4.6	4.7	4.9	3.8	4.2	4.4	250
255	5	5.6		5.5	5.6		5.1	5.6	5.8	4.4	4.6	4.7	3.5	3.8	4	255
260		3.6		5.4	5.4		4.6	5.3	5.4	4.1	4.4	4.5	3.2	3.5	3.7	260
265				4.9	5.3		4	4.7	4.8	3.8	4.1	4.3	2.9	3.2	3.3	265
270				3	4.6		3.5	4.1		3.3	3.9	4	2.6	2.9	3	270
275							3	3.5			3.5	3.6		2.6	2.6	275
280								2.9			2.5	2.6				280

t_240_002_50201_00_000 / 52201_00_000 / 54201_00_000

Lifting capacities

Forces de levage

TK



48 ft 87 ft	48 ft 87 ft			144 ft 87 ft			160 ft 87 ft			176 ft 87 ft			192 ft 87 ft			48 ft 87 ft
	0°	20°	40°	0°	20°	40°	0°	20°	40°	0°	20°	40°	0°	20°	40°	
14	19.4															14
15	19.4															15
16	19.4															16
17	19.4															17
18	19.4															18
19	19.5															19
20	19.4															20
22	19.3															22
24	19.1															24
26	18.9															26
28	18.5															28
30	18.2															30
32	17.8			19.4												32
34	17.5			19.4			18									34
36	17.1			19.5			18.1									36
38	16.8			19.5			18.1			16.5						38
40	16.4			19.4			18.1			16.6						40
45	15.6	13.5		19.2			18.1			16.6			14.9			45
50	14.8	12.7		18.8			17.8			16.5			15			50
55	14	11.9		18.3			17.5			16.4			14.9			55
60	13.1	11.2		17.8			17			16.1			14.7			60
65	12.4	10.6	8.9	17.2	13.4		16.6	13.1		15.7			14.5			65
70	11.6	10	8.5	16.7	12.9		16.2	12.7		15.4	12.4		14.3			70
75	10.9	9.5	8.1	16.2	12.4		15.8	12.3		15	12		14	11.6		75
80	10.3	9	7.8	15.7	12		15.3	11.9		14.7	11.7		13.7	11.3		80
85	9.7	8.5	7.5	15.2	11.5	8.7	14.9	11.5		14.3	11.3		13.4	11		85
90	9.1	8.2	7.3	14.8	11.1	8.5	14.5	11.1	8.5	14	11	8.4	13.2	10.7		90
95	8.6	7.8	7.1	14.3	10.8	8.3	14.1	10.8	8.3	13.6	10.7	8.2	12.9	10.4	8	95
100	8.2	7.5	6.9	13.8	10.5	8.1	13.7	10.5	8.1	13.3	10.4	8	12.6	10.1	7.9	100
105	7.8	7.3	6.8	13.3	10.1	8	13.3	10.2	7.9	13	10.1	7.9	12.3	9.8	7.8	105
110	7.3	7	6.8	12.9	9.8	7.8	12.9	9.9	7.8	12.6	9.8	7.7	12.1	9.6	7.6	110
115	7	6.9	6.8	12.4	9.5	7.6	12.5	9.6	7.6	12.3	9.6	7.6	11.8	9.3	7.5	115
120	6.7	6.8	6.8	12	9.3	7.5	12.1	9.3	7.5	12	9.3	7.5	11.5	9.1	7.4	120
125	6.5	6.8		11.5	9	7.4	11.7	9.1	7.4	11.6	9	7.3	11.3	8.9	7.3	125
130				11.1	8.8	7.3	11.4	8.8	7.3	11.3	8.8	7.2	11	8.7	7.2	130
135				10.7	8.5	7.2	11	8.6	7.2	11	8.6	7.1	10.7	8.5	7.1	135
140				10.3	8.3	7.1	10.6	8.4	7.1	10.7	8.4	7	10.4	8.3	7	140
145				10	8.1	7	10.2	8.2	7	10.4	8.2	7	10.2	8.2	6.9	145
150				9.6	7.9	6.9	9.9	8	6.9	10.1	8.1	6.9	9.9	8	6.8	150
155				9.3	7.8	6.9	9.6	7.9	6.9	9.8	7.9	6.8	9.7	7.8	6.8	155
160				9	7.6	6.8	9.3	7.7	6.8	9.5	7.7	6.8	9.4	7.7	6.7	160
165				8.8	7.4	6.8	9	7.6	6.8	9.2	7.6	6.7	9.2	7.5	6.7	165
170				8.5	7.3	6.8	8.8	7.4	6.8	9	7.4	6.7	8.9	7.4	6.6	170
175				8.2	7.2	6.8	8.5	7.3	6.7	8.7	7.3	6.7	8.7	7.3	6.6	175
180				7.9	7.1	6.8	8.3	7.2	6.7	8.5	7.2	6.6	8.5	7.2	6.6	180
185				7.7	7	6.8	8.1	7.1	6.7	8.2	7.1	6.6	8.3	7.1	6.6	185
190				7.5	6.9	6.8	7.9	7	6.7	8	7	6.6	8.1	7	6.5	190
195				7.2	6.9	6.8	7.6	6.9	6.7	7.9	6.9	6.6	7.9	6.9	6.5	195
200				7	6.8	6.8	7.4	6.8	6.7	7.7	6.9	6.6	7.7	6.8	6.5	200
205				6.9	6.8	5.4	7.3	6.8	6.7	7.5	6.8	6.6	7.6	6.8	6.5	205
210				6.7	6.8		7.1	6.8	6.7	7.4	6.7	6.6	7.5	6.7	6.5	210
215				6.6	6.8		6.9	6.8	6.5	7.2	6.7	6.6	7.3	6.7	6.5	215
220				6.1	6.8		6.8	6.8	5.1	7.1	6.7	6.6	7.2	6.6	6.5	220
225							6.6	6.8		6.9	6.7	6.6	7.1	6.6	6.5	225
230							6.5	6.8		6.8	6.6	6.2	6.9	6.6	6.5	230
235							4.4	6.6		6.6	6.6		6.8	6.6	6.5	235
240										6.6	6.6		6.7	6.6	6.5	240
245										5.7	6.6		6.6	6.6	5.9	245
250										2.8	5.1		6.5	6.5		250
255													6.2	6.4		255
260													4.4	6.2		260
265													3.9	4		265

t_240_002_50401_00_000 / 52401_00_000 / 54401_00_000

Lifting capacities Forces de levage

TK



Crane Icon	208 ft 87 ft			224 ft 87 ft			240 ft 87 ft			253 ft 87 ft			256 ft 87 ft			Crane Icon
	0°	20°	40°	0°	20°	40°	0°	20°	40°	0°	20°	40°	0°	20°	40°	
50	13.1															50
55	13.1			11.2												55
60	13.1			11.3			9.4									60
65	13			11.3			9.5			7.8			7.5			65
70	12.9			11.2			9.5			8.1			7.8			70
75	12.7			11.1			9.5			8.2			7.9			75
80	12.5	10.6		11			9.5			8.2			7.9			80
85	12.3	10.4		10.9			9.4			8.1			7.9			85
90	12.1	10.1		10.8	9.4		9.3			8			7.8			90
95	11.9	9.9		10.6	9.2		9.2	8.4		7.9			7.7			95
100	11.7	9.7		10.5	9		9.1	8.3		7.8	7.4		7.7			100
105	11.4	9.4	7.6	10.3	8.8		9	8.1		7.8	7.3		7.6	7.3		105
110	11.2	9.2	7.4	10.2	8.7	7.1	8.9	8		7.7	7.3		7.6	7.3		110
115	11	9	7.3	10	8.5	7.1	8.8	7.9	6.7	7.7	7.3		7.5	7.2		115
120	10.8	8.8	7.2	9.9	8.4	7	8.7	7.7	6.7	7.6	7.2		7.5	7.1		120
125	10.6	8.6	7.1	9.7	8.2	6.9	8.6	7.6	6.7	7.6	7.1	6.4	7.5	7	6.4	125
130	10.4	8.5	7	9.6	8	6.8	8.5	7.5	6.6	7.6	7	6.4	7.4	6.9	6.3	130
135	10.2	8.3	7	9.4	7.9	6.8	8.4	7.4	6.5	7.5	6.9	6.3	7.4	6.9	6.3	135
140	10	8.1	6.9	9.3	7.8	6.7	8.3	7.3	6.5	7.4	6.8	6.3	7.2	6.8	6.2	140
145	9.8	8	6.8	9.1	7.6	6.7	8.2	7.2	6.4	7.2	6.8	6.2	7.1	6.7	6.2	145
150	9.5	7.8	6.7	9	7.5	6.6	8.1	7.1	6.4	7.1	6.7	6.2	7	6.6	6.2	150
155	9.3	7.7	6.7	8.8	7.4	6.5	8	7	6.4	6.9	6.6	6.1	6.9	6.5	6.1	155
160	9.1	7.5	6.6	8.6	7.3	6.5	7.8	6.9	6.3	6.8	6.4	6.1	6.7	6.4	6.1	160
165	8.9	7.4	6.6	8.5	7.2	6.5	7.6	6.8	6.3	6.7	6.3	6	6.6	6.3	6	165
170	8.7	7.3	6.5	8.3	7.1	6.4	7.4	6.7	6.2	6.5	6.2	6	6.4	6.1	5.9	170
175	8.5	7.2	6.5	8.1	7	6.4	7.3	6.7	6.2	6.3	6	5.9	6.3	6	5.9	175
180	8.3	7.1	6.5	8	6.9	6.4	7.1	6.6	6.2	6.1	5.9	5.8	6.1	5.9	5.8	180
185	8.1	7	6.4	7.8	6.8	6.3	6.9	6.5	6.2	6	5.7	5.7	5.9	5.7	5.7	185
190	8	6.9	6.4	7.7	6.7	6.3	6.8	6.4	6.2	5.8	5.6	5.6	5.7	5.6	5.5	190
195	7.8	6.8	6.4	7.5	6.7	6.3	6.6	6.3	6.1	5.6	5.5	5.5	5.5	5.5	5.4	195
200	7.7	6.7	6.4	7.4	6.6	6.3	6.5	6.2	6.1	5.4	5.4	5.4	5.3	5.4	5.3	200
205	7.5	6.7	6.4	7.2	6.5	6.3	6.3	6	6	5.2	5.3	5.3	5.2	5.3	5.2	205
210	7.4	6.6	6.4	7.1	6.5	6.3	6.2	5.9	5.9	5	5.1	5.2	5	5.1	5.2	210
215	7.2	6.6	6.4	6.9	6.5	6.3	6.1	5.8	5.8	4.8	5	5.1	4.8	5	5.1	215
220	7.1	6.5	6.4	6.8	6.4	6.3	5.9	5.7	5.7	4.6	4.8	5	4.6	4.8	4.9	220
225	6.9	6.5	6.4	6.6	6.4	6.3	5.8	5.6	5.6	4.5	4.7	4.8	4.5	4.7	4.8	225
230	6.8	6.5	6.4	6.5	6.3	6.3	5.6	5.5	5.6	4.3	4.5	4.7	4.3	4.5	4.7	230
235	6.7	6.4	6.4	6.3	6.2	6.3	5.4	5.4	5.5	4.1	4.3	4.6	4.1	4.3	4.6	235
240	6.4	6.4	6.4	6	6.1	6.3	5.3	5.3	5.4	3.9	4.2	4.4	3.8	4.1	4.4	240
245	6	6.3	6.4	5.8	6	6.2	5.1	5.2	5.3	3.8	4	4.3	3.6	4	4.3	245
250	5.6	6.1	6.4	5.5	5.8	6.1	4.9	5	5.2	3.6	3.9	4.1	3.3	3.8	4.1	250
255	5.4	5.8	6	5.1	5.6	5.8	4.7	4.9	5.1	3.5	3.7	3.9	3	3.6	3.9	255
260	5.2	5.4	5.5	4.6	5.4	5.5	4.5	4.8	4.9	3.3	3.6	3.8	2.8	3.3	3.7	260
265	5.1	5.2		4.4	5	5.2	4.2	4.6	4.8	3.1	3.4	3.6		3.1	3.3	265
270	4.9	5		4.2	4.4	4.6	3.9	4.5	4.6		3.2	3.4		2.8	3	270
275	3.7	4.8		4.1	4.2	4.4	3.4	4.2	4.4		3	3.2		2.5	2.7	275
280		3.6		4	4.1		2.8	3.8	4		2.8	3			2.3	280
285				3.8	3.9			3.3	3.4			2.6				285
290				2.3	3.8			2.4	2.5							290

t_240_002_50401_00_000 / 52401_00_000 / 54401_00_000

Lifting heights Hauteurs de levage

TK

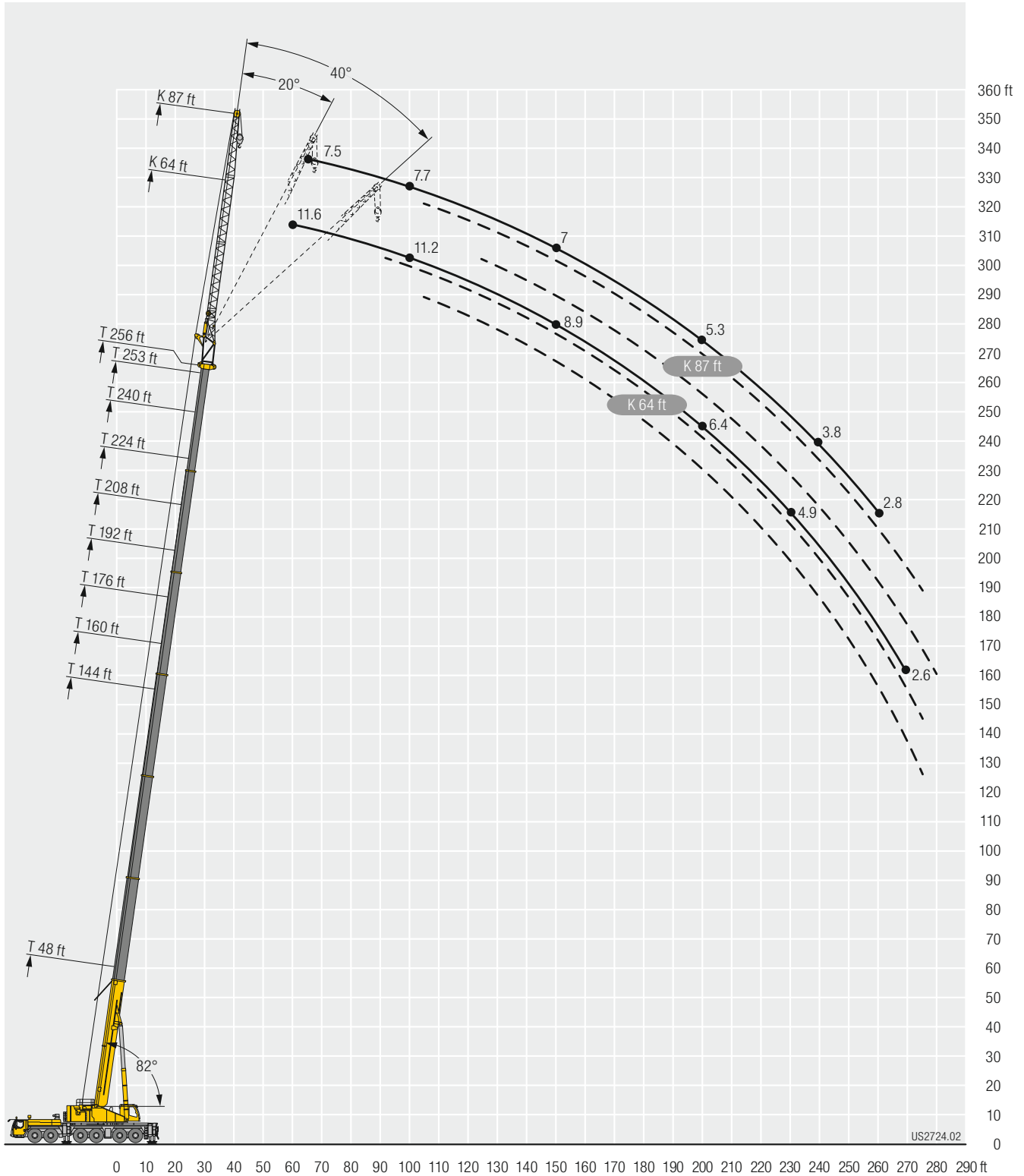

Lifting capacities Forces de levage

TK





Height (ft)	48 ft			144 ft			160 ft			176 ft			192 ft			Height (ft)
	0°	20°	40°	0°	20°	40°	0°	20°	40°	0°	20°	40°	0°	20°	40°	
15	15.9															15
16	15.9															16
17	15.9															17
18	15.9															18
19	15.9															19
20	16															20
22	15.9															22
24	15.9															24
26	15.8															26
28	15.6															28
30	15.4															30
32	15.2			15.4												32
34	15			15.8												34
36	14.8			15.9			14.9									36
38	14.5			16			15.1									38
40	14.3			15.9			15.2			14.1						40
45	13.7			15.9			15.2			14.2			12.9			45
50	13.1	11.6		15.7			15			14.2			13			50
55	12.5	10.9		15.4			14.8			14			13			55
60	11.9	10.3		15.1			14.6			13.8			12.9			60
65	11.2	9.7		14.8	12		14.3			13.6			12.7			65
70	10.6	9.2	7.8	14.4	11.6		14	11.5		13.3			12.5			70
75	10.1	8.8	7.5	14.1	11.2		13.7	11.1		13.1	10.9		12.3			75
80	9.5	8.3	7.2	13.7	10.8		13.4	10.7		12.8	10.5		12.1	10.2		80
85	9	8	7	13.4	10.5		13.1	10.4		12.6	10.2		11.9	9.9		85
90	8.5	7.6	6.8	13	10.1	7.8	12.8	10.1	7.8	12.3	9.9		11.6	9.7		90
95	8.1	7.3	6.7	12.6	9.8	7.6	12.5	9.8	7.6	12.1	9.7	7.5	11.4	9.4		95
100	7.7	7	6.5	12.3	9.5	7.5	12.2	9.5	7.4	11.8	9.4	7.4	11.2	9.2	7.2	100
105	7.3	6.8	6.4	11.9	9.2	7.3	11.9	9.3	7.3	11.5	9.1	7.2	11	8.9	7.1	105
110	7	6.6	6.3	11.5	9	7.2	11.5	9	7.2	11.3	8.9	7.1	10.8	8.7	7	110
115	6.7	6.5	6.3	11.2	8.7	7.1	11.2	8.8	7.1	11	8.7	7	10.6	8.5	6.9	115
120	6.5	6.4	6.3	10.8	8.5	7	10.9	8.5	6.9	10.7	8.5	6.9	10.4	8.3	6.8	120
125	6.2	6.3	6.3	10.5	8.2	6.9	10.6	8.3	6.8	10.4	8.3	6.8	10.1	8.1	6.7	125
130	6	6.3		10.1	8	6.8	10.3	8.1	6.7	10.2	8.1	6.7	9.9	8	6.6	130
135				9.8	7.8	6.7	9.9	7.9	6.7	9.9	7.9	6.6	9.7	7.8	6.6	135
140				9.4	7.6	6.6	9.7	7.7	6.6	9.7	7.7	6.6	9.4	7.6	6.5	140
145				9.1	7.4	6.5	9.3	7.5	6.5	9.4	7.5	6.5	9.2	7.5	6.4	145
150				8.8	7.3	6.5	9.1	7.4	6.4	9.1	7.4	6.4	9	7.3	6.4	150
155				8.5	7.2	6.4	8.8	7.2	6.4	8.9	7.3	6.4	8.8	7.2	6.3	155
160				8.3	7	6.4	8.6	7.1	6.3	8.6	7.1	6.3	8.6	7	6.3	160
165				8	6.9	6.3	8.3	7	6.3	8.4	7	6.2	8.4	6.9	6.2	165
170				7.8	6.8	6.3	8.1	6.9	6.3	8.2	6.9	6.2	8.2	6.8	6.1	170
175				7.6	6.7	6.3	7.8	6.7	6.2	8	6.8	6.2	7.9	6.7	6.1	175
180				7.4	6.6	6.3	7.6	6.7	6.2	7.8	6.7	6.1	7.8	6.6	6.1	180
185				7.2	6.5	6.3	7.5	6.6	6.2	7.6	6.6	6.1	7.6	6.6	6.1	185
190				7	6.4	6.3	7.3	6.5	6.2	7.4	6.5	6.1	7.4	6.5	6	190
195				6.8	6.4	6.3	7.1	6.4	6.2	7.2	6.4	6.1	7.3	6.4	6	195
200				6.7	6.3	6.3	7	6.4	6.2	7.1	6.4	6.1	7.1	6.4	6	200
205				6.5	6.3	6.3	6.8	6.3	6.2	7	6.3	6.1	7	6.3	6	205
210				6.4	6.3	5.4	6.7	6.3	6.2	6.8	6.3	6.1	6.9	6.2	6	210
215				6.2	6.3		6.6	6.2	6.2	6.7	6.2	6.1	6.8	6.2	6	215
220				6.1	6.3		6.4	6.2	6.2	6.6	6.2	6.1	6.7	6.1	6	220
225				5.7	6.3		6.3	6.2	5.1	6.5	6.2	6.1	6.6	6.1	6	225
230							6.2	6.2		6.4	6.2	6.1	6.5	6.1	6	230
235							6.1	6.2		6.3	6.2	6	6.4	6.1	6	235
240							4.1	6.2		6.2	6.2		6.3	6.1	6	240
245										6.1	6.2		6.2	6.1	6	245
250										5.4	6.2		6.1	6.1	5.7	250
255										2.6	4.9		6	6		255
260													5.9	6		260
265													4.1	6		265
270													3.8	3.9		270

t_240_002_50501_00_000 / 52501_00_000 / 54501_00_000

Lifting capacities Forces de levage

TK



	208 ft			224 ft			240 ft			253 ft			256 ft			
	92 ft			92 ft			92 ft			92 ft			92 ft			
	0°	20°	40°	0°	20°	40°	0°	20°	40°	0°	20°	40°	0°	20°	40°	
50	11.5															50
55	11.5			9.9												55
60	11.5			10.1			8.2									60
65	11.5			10.2			8.5			6.9						65
70	11.4			10.1			8.7			7.2			6.9			70
75	11.2			10			8.7			7.4			7.1			75
80	11.1			9.9			8.6			7.5			7.3			80
85	10.9	9.4		9.8			8.5			7.5			7.3			85
90	10.7	9.2		9.7	8.5		8.4			7.5			7.3			90
95	10.6	9		9.6	8.4		8.4			7.4			7.3			95
100	10.4	8.8		9.4	8.2		8.3	7.5		7.4			7.3			100
105	10.3	8.6		9.3	8.1		8.2	7.4		7.3	6.9		7.2	6.8		105
110	10.1	8.4	6.9	9.2	7.9		8.1	7.3		7.3	6.8		7.1	6.8		110
115	9.9	8.2	6.8	9.1	7.7	6.6	8	7.2		7.2	6.8		7.1	6.7		115
120	9.7	8	6.7	8.9	7.6	6.5	7.9	7.1	6.2	7.2	6.7		7	6.6		120
125	9.6	7.9	6.6	8.8	7.5	6.4	7.8	7	6.2	7.1	6.6		7	6.5		125
130	9.4	7.7	6.5	8.7	7.3	6.3	7.7	6.9	6.1	7	6.5	5.9	6.9	6.4	5.8	130
135	9.2	7.6	6.4	8.6	7.2	6.3	7.7	6.8	6.1	7	6.4	5.9	6.9	6.4	5.8	135
140	9	7.4	6.4	8.4	7.1	6.2	7.6	6.7	6	6.9	6.4	5.8	6.8	6.3	5.8	140
145	8.8	7.3	6.3	8.3	7	6.2	7.5	6.6	6	6.8	6.3	5.8	6.7	6.2	5.8	145
150	8.7	7.1	6.3	8.1	6.9	6.1	7.4	6.5	5.9	6.7	6.2	5.7	6.6	6.2	5.7	150
155	8.5	7	6.2	8	6.8	6.1	7.3	6.5	5.9	6.6	6.2	5.7	6.5	6.1	5.7	155
160	8.3	6.9	6.1	7.9	6.7	6	7.2	6.4	5.9	6.5	6.1	5.7	6.4	6.1	5.7	160
165	8.1	6.8	6.1	7.7	6.6	6	7.1	6.3	5.8	6.4	6	5.7	6.4	6	5.6	165
170	7.9	6.7	6.1	7.6	6.5	5.9	7	6.3	5.8	6.3	5.9	5.6	6.2	5.9	5.6	170
175	7.8	6.7	6	7.4	6.4	5.9	6.9	6.2	5.8	6.2	5.8	5.6	6.1	5.8	5.6	175
180	7.6	6.6	6	7.3	6.4	5.9	6.8	6.1	5.7	6	5.7	5.6	6	5.7	5.6	180
185	7.4	6.5	6	7.2	6.3	5.9	6.7	6.1	5.7	5.8	5.6	5.5	5.8	5.6	5.5	185
190	7.3	6.4	5.9	7.1	6.2	5.8	6.6	6	5.7	5.7	5.5	5.4	5.6	5.5	5.4	190
195	7.1	6.3	5.9	7	6.2	5.8	6.5	6	5.7	5.5	5.4	5.3	5.5	5.4	5.3	195
200	7	6.3	5.9	6.8	6.1	5.8	6.3	5.9	5.7	5.3	5.3	5.3	5.3	5.3	5.2	200
205	6.9	6.2	5.9	6.7	6.1	5.8	6.2	5.8	5.7	5.1	5.2	5.2	5.1	5.1	5.2	205
210	6.8	6.2	5.9	6.6	6	5.8	6.1	5.7	5.7	5	5	5.1	4.9	5	5.1	210
215	6.7	6.1	5.9	6.5	6	5.8	5.9	5.6	5.6	4.8	4.9	5	4.8	4.9	5	215
220	6.6	6	5.9	6.5	5.9	5.8	5.8	5.5	5.6	4.6	4.8	4.9	4.6	4.7	4.9	220
225	6.5	6	5.9	6.4	5.9	5.8	5.7	5.5	5.5	4.5	4.6	4.8	4.4	4.6	4.8	225
230	6.4	6	5.9	6.3	5.9	5.8	5.5	5.4	5.4	4.3	4.5	4.7	4.3	4.5	4.7	230
235	6.4	6	5.9	6.2	5.8	5.8	5.4	5.3	5.4	4.1	4.3	4.6	4.1	4.3	4.5	235
240	6.3	5.9	5.9	6	5.8	5.8	5.2	5.2	5.3	4	4.2	4.5	3.9	4.1	4.4	240
245	6.1	5.9	5.9	5.8	5.7	5.8	5.1	5.1	5.2	3.8	4	4.3	3.7	4	4.3	245
250	5.8	5.9	5.9	5.6	5.7	5.8	4.9	5	5.1	3.7	3.9	4.1	3.4	3.8	4.1	250
255	5.4	5.8	5.9	5.3	5.6	5.8	4.7	4.9	5	3.5	3.7	4	3.2	3.6	4	255
260	5.3	5.6	5.8	4.9	5.5	5.7	4.5	4.7	4.9	3.3	3.6	3.8	2.9	3.4	3.8	260
265	5.1	5.2	5.3	4.4	5.2	5.4	4.3	4.6	4.8	3.2	3.4	3.6	2.6	3.2	3.5	265
270	4.9	5.1		4.2	4.8	5	4.1	4.5	4.6	3	3.3	3.5	2.4	3	3.2	270
275	4.7	4.9		4.1	4.2	4.4	3.7	4.3	4.4	2.7	3.1	3.3		2.7	2.9	275
280	3.6	4.7		3.9	4.1	4.2	3.2	4.1	4.2		2.9	3.1		2.4	2.5	280
285		3.5		3.8	4		2.8	3.7	3.8		2.8	3			2.2	285
290				3.6	3.8		2.1	3.1	3.3			2.7				290
295					3.6			2.6	2.7							295

t_240_002_50501_00_000 / 52501_00_000 / 54501_00_000

Lifting capacities Forces de levage

TK



↙ ↘	48 ft			144 ft			160 ft			176 ft			192 ft			↙ ↘	
	0°	20°	40°	0°	20°	40°	0°	20°	40°	0°	20°	40°	0°	20°	40°		
19	9.1															19	
20	9.1															20	
22	9.2															22	
24	10.1															24	
26	10.8															26	
28	11.2															28	
30	11.1															30	
32	10.9															32	
34	10.8															34	
36	10.6				9.3											36	
38	10.5				9.7											38	
40	10.3				10			9.1								40	
45	9.9				10.7			9.8			8.7					45	
50	9.5				11			10.3			9.2			7.8		50	
55	9				10.9			10.4			9.6			8.3		55	
60	8.6	7.4			10.7			10.2			9.7			8.7		60	
65	8.2	7			10.4			10			9.5			8.8		65	
70	7.7	6.6			10.2			9.8			9.4			8.7		70	
75	7.2	6.3			9.9			9.6			9.2			8.6		75	
80	6.8	6			9.7	7.3		9.4	7.2		9			8.4		80	
85	6.5	5.7			9.4	7.1		9.2	7		8.8	6.9		8.2		85	
90	6.1	5.5	4.8		9.1	6.9		8.9	6.8		8.6	6.7		8.1	6.4	90	
95	5.8	5.2	4.6		8.8	6.6		8.7	6.6		8.4	6.5		7.9	6.3	95	
100	5.6	5	4.5		8.6	6.4		8.4	6.4		8.2	6.3		7.7	6.2	100	
105	5.3	4.8	4.3		8.3	6.2	4.6	8.2	6.2		7.9	6.1		7.5	6	105	
110	5.1	4.6	4.2		8	6.1	4.5	7.9	6	4.5	7.7	6		7.4	5.8	110	
115	4.9	4.4	4.1		7.7	5.9	4.5	7.7	5.9	4.5	7.5	5.8	4.4	7.2	5.7	115	
120	4.7	4.3	3.9		7.4	5.7	4.4	7.4	5.7	4.4	7.3	5.7	4.3	7	5.6	4.3	120
125	4.5	4.1	3.9		7.1	5.6	4.4	7.2	5.6	4.3	7.1	5.5	4.3	6.8	5.4	4.2	125
130	4.3	4	3.8		6.9	5.4	4.3	6.9	5.4	4.3	6.9	5.4	4.2	6.7	5.3	4.2	130
135	4.2	3.9	3.8		6.6	5.3	4.2	6.7	5.3	4.2	6.7	5.3	4.2	6.5	5.2	4.1	135
140	4	3.8	3.8		6.4	5.1	4.2	6.5	5.2	4.2	6.5	5.1	4.2	6.3	5.1	4.1	140
145	3.9	3.8	3.8		6.2	5	4.2	6.3	5	4.2	6.3	5	4.1	6.2	5	4	145
150	3.8	3.8			6	4.9	4.1	6.1	4.9	4.1	6.1	4.9	4.1	6	4.8	4	150
155	3.7	3.8			5.8	4.8	4.1	5.9	4.8	4	6	4.8	4	5.9	4.7	4	155
160					5.7	4.6	4	5.8	4.7	4	5.8	4.7	4	5.7	4.6	3.9	160
165					5.5	4.6	3.9	5.6	4.6	3.9	5.7	4.6	3.9	5.6	4.6	3.9	165
170					5.3	4.5	3.9	5.5	4.5	3.9	5.5	4.5	3.9	5.5	4.5	3.8	170
175					5.2	4.4	3.9	5.3	4.4	3.8	5.3	4.4	3.8	5.3	4.4	3.8	175
180					5	4.3	3.8	5.2	4.3	3.8	5.2	4.3	3.8	5.2	4.3	3.7	180
185					4.9	4.2	3.8	5	4.2	3.8	5.1	4.3	3.7	5.1	4.2	3.7	185
190					4.8	4.1	3.8	4.9	4.2	3.8	5	4.2	3.7	4.9	4.2	3.7	190
195					4.7	4	3.8	4.8	4.1	3.7	4.9	4.1	3.7	4.8	4.1	3.6	195
200					4.5	4	3.8	4.7	4	3.7	4.7	4	3.7	4.7	4	3.6	200
205					4.4	3.9	3.8	4.6	4	3.7	4.6	4	3.6	4.6	4	3.6	205
210					4.3	3.9	3.8	4.4	3.9	3.7	4.5	3.9	3.6	4.5	3.9	3.6	210
215					4.2	3.8	3.8	4.3	3.9	3.7	4.4	3.9	3.6	4.4	3.8	3.6	215
220					4.1	3.8	3.8	4.2	3.8	3.7	4.3	3.8	3.6	4.3	3.8	3.6	220
225					4	3.8	3.8	4.2	3.8	3.7	4.3	3.8	3.6	4.2	3.8	3.6	225
230					4	3.8	3.8	4.1	3.7	3.7	4.2	3.7	3.6	4.2	3.7	3.6	230
235					3.9	3.8		4	3.7	3.7	4.1	3.7	3.6	4.1	3.7	3.6	235
240					3.8	3.8		3.9	3.7	3.7	4	3.7	3.6	4	3.6	3.6	240
245					3.8	3.8		3.9	3.7		3.9	3.7	3.6	4	3.6	3.6	245
250								3.8	3.7		3.9	3.6	3.6	3.9	3.6	3.6	250
255								3.7	3.7		3.8	3.6	3.6	3.8	3.6	3.6	255
260								3.7	3.7		3.7	3.6	3.6	3.8	3.6	3.6	260
265											3.7	3.6		3.7	3.6	3.6	265
270											3.7	3.6		3.7	3.6	3.6	270
275											2.5	3.6		3.6	3.6		275
280														3.6	3.6		280
285														3.3	3.6		285
290														2.4	3.4		290
295															2.5		295

t_240_002_50601_00_000 / 52601_00_000 / 54601_00_000

Lifting capacities

Forces de levage

TK



↙ ↘	208 ft 115 ft			224 ft 115 ft			240 ft 115 ft			253 ft 115 ft			256 ft 115 ft		↙ ↘
	0°	20°	40°	0°	20°	40°	0°	20°	40°	0°	20°	40°	0°	20°	
55	6.7														55
60	7.1			5.6											60
65	7.5			5.9			4.6								65
70	7.6			6.3			4.8								70
75	7.7			6.5			5.1			4			3.8		75
80	7.6			6.6			5.3			4			3.8		80
85	7.5			6.6			5.4			4.1			3.8		85
90	7.3			6.6			5.5			4.2			3.8		90
95	7.2			6.6			5.6			4.3			3.8		95
100	7.1	5.9		6.5			5.6			4.3			3.9		100
105	7	5.8		6.4	5.4		5.6			4.3			3.9		105
110	6.8	5.6		6.3	5.3		5.6			4.3			3.9		110
115	6.7	5.5		6.2	5.2		5.5	4.7		4.3			3.9		115
120	6.6	5.4		6.1	5.1		5.5	4.7		4.4	4.2		3.9	4.1	120
125	6.5	5.3	4.1	6	5		5.4	4.7		4.4	4.2		3.9	4.1	125
130	6.3	5.1	4	5.9	4.9		5.3	4.6		4.4	4.2		3.9	4.1	130
135	6.2	5	4	5.8	4.8	3.8	5.3	4.5		4.4	4.2		3.9	4.1	135
140	6.1	4.9	4	5.6	4.7	3.8	5.2	4.4	3.6	4.4	4.1		3.9	4	140
145	5.9	4.8	3.9	5.5	4.6	3.8	5.1	4.4	3.6	4.3	4.1		3.9	4	145
150	5.8	4.7	3.9	5.4	4.5	3.8	5	4.3	3.6	4.3	4	3.4	3.9	4	150
155	5.7	4.6	3.9	5.3	4.4	3.7	4.9	4.2	3.6	4.2	4	3.4	3.9	4	155
160	5.5	4.5	3.8	5.2	4.4	3.7	4.8	4.1	3.5	4.2	3.9	3.4	3.9	3.9	160
165	5.4	4.4	3.8	5.1	4.3	3.7	4.8	4.1	3.5	4.2	3.9	3.3	3.9	3.9	165
170	5.3	4.4	3.8	5	4.2	3.6	4.7	4	3.5	4.1	3.8	3.3	3.8	3.8	170
175	5.2	4.3	3.7	4.9	4.2	3.6	4.6	4	3.5	4.1	3.8	3.3	3.8	3.8	175
180	5	4.2	3.7	4.8	4.1	3.6	4.5	3.9	3.5	4	3.7	3.3	3.7	3.7	180
185	4.9	4.1	3.6	4.7	4	3.6	4.5	3.8	3.4	4	3.7	3.3	3.7	3.7	185
190	4.8	4.1	3.6	4.7	3.9	3.5	4.4	3.8	3.4	3.9	3.6	3.3	3.7	3.6	190
195	4.7	4	3.6	4.6	3.9	3.5	4.3	3.7	3.4	3.9	3.6	3.3	3.6	3.6	195
200	4.6	4	3.5	4.5	3.9	3.5	4.2	3.7	3.4	3.8	3.5	3.3	3.6	3.5	200
205	4.5	3.9	3.5	4.4	3.8	3.5	4.2	3.6	3.4	3.7	3.5	3.3	3.6	3.5	205
210	4.4	3.8	3.5	4.3	3.8	3.4	4.1	3.6	3.4	3.7	3.5	3.3	3.5	3.4	210
215	4.4	3.8	3.5	4.3	3.7	3.4	4	3.6	3.3	3.6	3.4	3.2	3.5	3.4	215
220	4.3	3.7	3.5	4.2	3.7	3.4	4	3.5	3.3	3.5	3.4	3.2	3.5	3.4	220
225	4.2	3.7	3.5	4.1	3.6	3.4	3.9	3.5	3.3	3.4	3.3	3.2	3.3	3.4	225
230	4.1	3.7	3.5	4	3.6	3.4	3.9	3.5	3.3	3.2	3.3	3.2	3.2	3.3	230
235	4.1	3.6	3.5	4	3.5	3.4	3.8	3.4	3.3	3.1	3.2	3.2	3.1	3.2	235
240	4	3.6	3.5	3.9	3.5	3.4	3.8	3.4	3.3	2.9	3.1	3.2	2.9	3.1	240
245	3.9	3.6	3.5	3.9	3.5	3.4	3.7	3.4	3.3	2.8	3	3.2	2.8	3	245
250	3.9	3.5	3.5	3.8	3.4	3.4	3.6	3.4	3.3	2.6	2.9	3.1	2.6	2.9	250
255	3.8	3.5	3.5	3.7	3.4	3.4	3.5	3.3	3.3	2.5	2.8	3.1	2.5	2.8	255
260	3.8	3.5	3.5	3.7	3.4	3.4	3.5	3.3	3.3	2.3	2.7	3	2.3	2.6	260
265	3.7	3.5	3.5	3.6	3.4	3.4	3.4	3.3	3.3	2.2	2.5	2.8		2.5	265
270	3.7	3.5	3.5	3.5	3.4	3.4	3.3	3.3	3.3		2.4	2.7		2.4	270
275	3.6	3.5	3.5	3.4	3.4	3.4	3.2	3.2	3.3		2.2	2.5		2.2	275
280	3.5	3.5	3.5	3.2	3.3	3.4	3	3.1	3.3			2.4			280
285	3.5	3.5		2.9	3.3	3.4		3.1	3.3			2.2			285
290	3.5	3.5		2.8	3.2	3.4		3	3.3						290
295	3.3	3.5		2.6	2.8	3.2		2.8	3.1						295
300	2.2	3.4		2.5	2.7				2.7						300
305		2.6			2.6										305
310					2.4										310

L_240_002_50601_00_000 / 52601_00_000 / 54601_00_000

Lifting heights Hauteurs de levage

TK

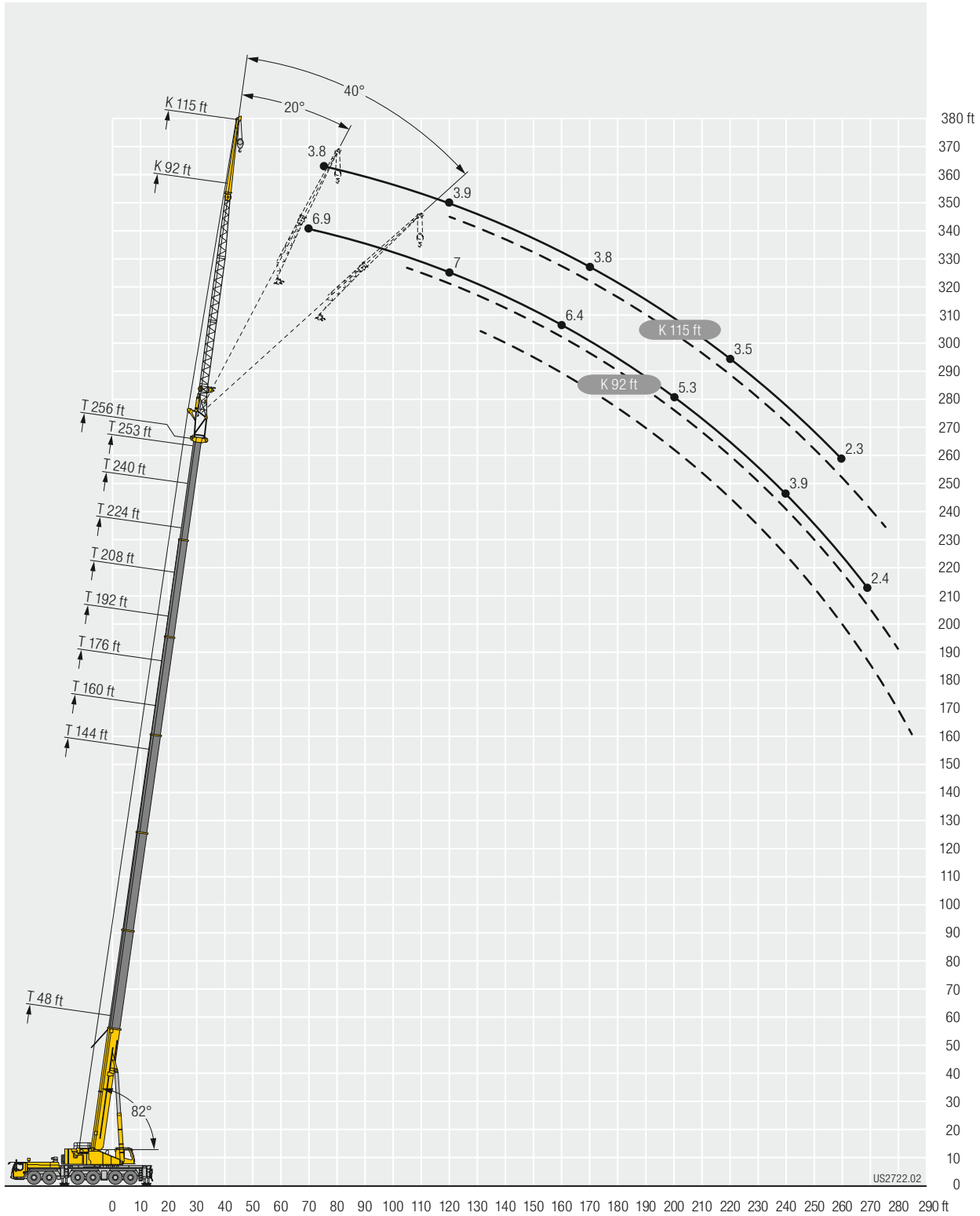

Lifting capacities Forces de levage

TNZK



	48 ft			64 ft			80 ft			96 ft			112 ft			128 ft			144 ft			160 ft			
	18 ft			18 ft			18 ft			18 ft			18 ft			18 ft			18 ft			18 ft			
	0°	20°	40°	0°	20°	40°	0°	20°	40°	0°	20°	40°	0°	20°	40°	0°	20°	40°	0°	20°	40°	0°	20°	40°	
12	128.3	101.2																						12	
13	125.9	99.2	84.3	130.9	103																			13	
14	122.7	97.2	82.9	130.3	101.1		130.4																	14	
15	119.5	95.3	81.7	127.6	99.4	83.9	129.2	100.7																15	
16	116.3	93.5	80.5	124.9	97.8	82.8	127.4	99.6	126.8															16	
17	113.7	91.8	79.3	122.4	96.2	81.8	125.2	98.2	125.1															17	
18	111.2	90.1	78.2	120	94.7	80.8	123.1	96.8	81.8	123.4	97.5		121.2											18	
19	108.6	88.4	77.1	117.6	93.3	79.9	121	95.5	81	121.7	96.4		119.9											19	
20	106	86.9	76.1	115.2	91.9	78.9	119	94.2	80.2	120	95.3		118.6											20	
22	101.2	84	74	110.7	89.2	77.1	115.1	91.7	78.5	116.6	93	79.4	115.9	93.5	105.6									22	
24	96.9	81.1	72.2	106.7	86.4	75.3	111.2	89.2	77	113.1	90.8	77.9	113.1	91.5	78.3	105.6	91.1							24	
26	92.9	78.6	70.4	102.6	84.1	73.6	107.5	87	75.4	109.9	88.7	76.5	110.2	89.5	77	105.3	89.6	95.2						26	
28	89.1	76.1	68.8	98.8	81.8	72.2	104.2	84.8	74.1	106.9	86.7	75.2	107.5	87.6	75.8	104.7	88.2	76.8	94.7	83.6				28	
30	86	73.8	67.3	95.4	79.5	70.8	101.1	82.8	72.7	103.9	84.8	73.9	104.8	85.8	74.6	103.9	86.9	75.8	94.2	82.7	79.4			30	
32	82.8	71.9	65.9	92.3	77.5	69.4	98	81	71.4	100.9	83	72.8	102.4	84.2	73.5	102.4	85.6	74.8	93.4	81.7	73	79.4		32	
34	79.9	70.1	64.7	89.2	75.6	68.2	95.1	79.2	70.2	98.5	81.2	71.6	100.1	82.6	72.4	100.8	84.3	73.9	92.4	80.7	72.2	79.3	73.9	34	
36	77.4	68.3	63.6	86.5	73.8	67	92.4	77.5	69.1	96.1	79.6	70.5	97.8	81.1	71.4	99.1	83.1	73	91.5	79.8	71.4	79	73.3	67.7	36
38	74.9	66.7	62.6	84.1	72.1	65.9	89.9	75.9	68	93.7	78.2	69.5	95.6	79.7	70.5	97.4	81.8	72.2	90.4	78.8	70.7	78.6	72.7	67.2	38
40	72.6	65.2	61.7	81.7	70.7	64.9	87.6	74.3	67	91.4	76.8	68.5	93.6	78.2	69.5	95.7	80.6	71.3	89.3	77.9	69.9	78.2	72	66.6	40
45	67.9	62.2	60.1	76.3	67.2	62.7	82.3	70.8	64.8	86.3	73.3	66.3	88.9	75.2	67.4	91.6	77.6	69.4	86.3	75.4	68.2	76.5	70.2	65.2	45
50	64.1	59.9	59.4	71.7	64.3	60.9	77.7	67.9	62.9	81.8	70.4	64.3	84.4	72.3	65.5	88	75	67.5	83.1	73.2	66.6	73.6	67.9	63.7	50
55	60.5	58.2	9.1	68	61.9	59.7	73.7	65.2	61.2	78	67.8	62.6	80.7	69.7	63.7	84.3	72.5	66	78.7	71	65.1	69.8	65.1	61.7	55
60				64.7	59.9	32.6	70.2	63	59.9	74.4	65.6	61.2	77.2	67.3	62.2	81.2	70.2	64.4	73.8	69	63.8	66.1	62.3	59.3	60
65				62.2	58.8	16	67.2	61.1	58.9	71.2	63.4	59.9	74.2	65.3	60.9	78.2	68.3	63.1	69.1	66.9	62.6	62.5	59.9	57.1	65
70				59.3	57.5	9.5	64.5	59.6	47.6	68.4	61.7	59	71.4	63.5	59.8	74.8	66.5	61.9	64.9	64.3	61	59	57.5	55.1	70
75				41.9			62.3	58.4	22.2	65.9	60.1	58.1	68.9	61.7	58.8	68.5	64.9	60.9	60.9	60.6	58.8	55.6	55.1	53.1	75
80							60.5	57.8	13.8	63.9	58.9	57.8	64.2	60.4	58	62.6	63	60.1	57.1	56.9	56.4	52.7	52.5	51.1	80
85							58.2	55.9	9.2	60.2	57.8	29	59	59	57.4	57.3	57.9	58	53.7	53.6	53.6	49.8	49.8	49	85
90							40.8	13.5		55.6	55.9	18.1	54.4	54.8	55	52.7	53.3	53.5	51.4	50.4	50.5	47.2	47.2	46.9	90
95										51.5	51.8	12.5	50.2	50.6	37.1	48.6	49.1	49.3	49.3	47.1	47.4	44.9	44.8	44.8	95
100										47.9	44.9	9	46.6	46.9	22.6	44.9	45.3	45.5	46.2	45.1	44.3	42.6	42.6	42.6	100
105										35.8	15.6	5.7	43.3	43.5	15.8	43.1	41.9	40.7	42.9	43.1	42.9	40.3	40.4	40.5	105
110													40.3	40.5	11.7	41.4	40.2	27.7	39.9	40.2	40.4	38.2	38.2	38.3	110
115													37.6	37.7	8.9	38.9	39	19.2	37.1	37.4	37.6	35.5	35.9	36.1	115
120													31	17	6.3	36.4	36.6	14.4	34.6	34.9	32.4	33	33.3	33.5	120
125																34.1	34.3	11.2	32.3	32.5	22.8	31.3	31.4	31.5	125
130																32	32.1	8.8	30.2	30.4	17.2	29.5	29.8	29.9	130
135																25	18.2	6.6	28.2	28.3	13.5	27.5	27.7	26.7	135
140																			26.3	26.4	10.8	25.6	25.8	20.1	140
145																			24.6	24.7	8.7	23.8	24	15.8	145
150																			20.7	19	6.9	22.2	22.4	12.7	150
155																						20.7	20.9	10.5	155
160																						19.4	19.4	8.6	160
165																						16.4	16.4	7	165
170																						10.5	9.4		170

L_240_002_56001_00_000

Lifting capacities Forces de levage

TNZK



↙ ↘	176 ft			192 ft			208 ft			224 ft			240 ft			253 ft			256 ft			↙ ↘
	18 ft			18 ft			18 ft			18 ft			18 ft			18 ft			18 ft			
	0°	20°	40°	0°	20°	40°	0°	20°	40°	0°	20°	40°	0°	20°	40°	0°	20°	40°	0°	20°	40°	
34	64.7																					34
36	64.5																					36
38	64.2	64.7		51.5																		38
40	64	64.5		51.3																		40
45	63.2	63.7	61	50.8	51.2	51.4	41.6															45
50	62.2	62.8	60	50.3	50.7	51.2	41.2	41.5	42.2	34				25.4								50
55	60.7	60.6	58.7	49.7	50	50.5	40.9	41.2	41.3	33.8	33.8	34.1	25.3	25.4		21				20.4		55
60	57.9	57.8	56.7	48.7	48.8	49	40.3	40.1	40.2	33.2	33.2	33.5	25.1	25.2	25.1	21	21			20.4	20.4	60
65	55	54.9	54.4	46.9	47	47.2	39.1	38.9	39	32.5	32.4	32.6	24.9	24.9	25	20.9	20.9	20.9	20.3	20.4	20.3	65
70	52.2	52.2	52.1	44.9	45	45.3	37.9	37.7	37.7	31.6	31.4	31.5	24.6	24.5	24.6	20.7	20.7	20.8	20.2	20.3	20.3	70
75	49.6	49.5	49.7	43	43.1	43.3	36.6	36.4	36.3	30.6	30.3	30.4	24.1	24	24.1	20.4	20.3	20.4	20	20	20.1	75
80	46.9	4	47.1	41.1	41.1	41.4	35.3	35	34.9	29.5	29.3	29.3	23.5	23.4	23.5	19.9	19.9	19.9	19.6	19.6	19.6	80
85	44.4	44.4	44.6	39.2	39.2	39.5	34	33.7	33.6	28.5	28.3	28.3	22.8	22.8	22.8	19.4	19.3	19.4	19.1	19.1	19.1	85
90	42.1	42.1	42.3	37.3	37.4	37.6	32.7	32.4	32.3	27.5	27.3	27.3	22.2	22.1	22.2	18.8	18.7	18.8	18.6	18.5	18.5	90
95	39.8	40	40.1	35.5	35.6	35.8	31.4	31.2	31.1	26.6	26.3	26.3	21.5	21.4	21.5	18.2	18.1	18.2	18	17.9	18	95
100	37.7	37.8	38	33.8	33.9	34.1	30.1	30	29.9	25.6	25.4	25.4	20.9	20.7	20.8	17.6	17.5	17.6	17.4	17.4	17.4	100
105	35.9	35.9	36	32.1	32.2	32.5	28.9	28.8	28.8	24.7	24.5	24.5	20.2	20.1	20.1	17	16.9	17	16.8	16.8	16.8	105
110	34	34.2	34.3	30.6	30.6	30.9	27.6	27.6	27.6	23.7	23.6	23.6	19.5	19.4	19.5	16.5	16.4	16.4	16.3	16.2	16.3	110
115	32.2	32.4	32.5	29.1	29.2	29.4	26.3	26.4	26.5	22.9	22.7	22.7	18.9	18.8	18.8	15.9	15.8	15.9	15.8	15.7	15.7	115
120	30.6	30.7	30.8	27.7	27.8	28	25.1	25.2	25.3	22.1	21.9	21.9	18.2	18.1	18.2	15.4	15.3	15.4	15.3	15.2	15.2	120
125	29.1	29.2	29.3	26.3	26.5	26.6	24	24	24.2	21.3	21.2	21.2	17.6	17.5	17.6	14.8	14.8	14.8	14.7	14.7	14.7	125
130	27.7	27.7	27.9	25	25.2	25.3	22.9	23	23.1	20.5	20.4	20.4	17.1	17	17	14.3	14.3	14.3	14.3	14.2	14.2	130
135	25.8	26.1	26.3	23.8	23.9	24	21.8	22	22.1	19.7	19.6	19.7	16.5	16.4	16.5	13.8	13.8	13.8	13.8	13.7	13.8	135
140	23.9	24.2	24.4	22.7	22.8	22.9	20.8	20.9	21	19	18.9	19	15.9	15.9	15.9	13.4	13.4	13.4	13.3	13.3	13.3	140
145	22.9	22.9	23	21.5	21.7	21.8	19.8	19.9	20	18.2	18.2	18.3	15.4	15.4	15.4	12.9	12.9	12.9	12.9	12.8	12.9	145
150	21.9	21.9	22	20.5	20.6	20.7	18.9	19	19.1	17.5	17.5	17.6	15	14.9	14.9	12.5	12.5	12.5	12.4	12.4	12.4	150
155	20.6	20.8	18.2	19.2	19.5	19.6	17.9	18.1	18.2	16.7	16.8	16.9	14.5	14.4	14.5	12.1	12.1	12.1	12	12	12	155
160	19.2	19.3	14.7	17.8	18.1	18.1	17.1	17.2	17.3	16	16.1	16.2	14	14	14	11.7	11.7	11.7	11.7	11.6	11.7	160
165	17.8	18	12.2	17	17.1	17.1	16.2	16.3	16.4	15.3	15.4	15.4	13.6	13.5	13.6	11.3	11.3	11.3	11.3	11.3	11.3	165
170	16.6	16.7	10.2	16.3	16.3	16.4	15.4	15.6	15.6	14.6	14.6	14.7	13.1	13.1	13.1	10.9	10.9	11	10.9	10.9	10.9	170
175	15.5	15.6	8.6	15.7	15.7	13.9	14.5	14.7	14.7	13.8	13.9	14	12.7	12.7	12.7	10.6	10.6	10.6	10.6	10.6	10.6	175
180	13.1	13.2	7.1	14.8	14.9	11.8	13.5	13.5	13.6	13.2	13.3	13.3	12.3	12.3	12.3	10.2	10.2	10.2	10.2	10.2	10.2	180
185	9.3	9.1		13.8	13.9	10	12.9	12.9	13	12.6	12.7	12.7	11.9	11.9	11.9	9.8	9.8	9.9	9.7	9.8	9.8	185
190				12.8	12.9	8.6	12.4	12.5	12.5	11.4	11.4	11.5	11.5	11.5	11.6	9.5	9.5	9.5	9.2	9.3	9.3	190
195				10.7	10.7	7.2	11.9	12	11.4	10.9	11	11	11	11	11.1	9.1	9.1	9.2	8.8	8.8	8.9	195
200				7.7	7.7	5.1	11.4	11.4	9.9	9.4	9.7	9.8	10.5	10.6	10.6	8.8	8.8	8.9	8.3	8.4	8.4	200
205							9.8	9.9	8.5	7.5	7.9	7.8	10	10.1	10.1	8.5	8.5	8.5	7.9	7.9	8	205
210							8.8	8.8	7.3	5.7	6	6	9.5	9.6	9.6	8.1	8.2	8.2	7.5	7.5	7.5	210
215							5.7	5.8	4.2	4	4.3	4.2	8.8	8.9	8.9	7.8	7.9	7.9	7.1	7.1	7.1	215
220										2.4	2.6	2.3	8.1	8.2	8.2	7.5	7.6	7.6	6.7	6.7	6.7	220
225													7.4	7.5	7.5	7.2	7.2	7.3	6.3	6.3	6.3	225
230													6.9	6.9	6.9	6.9	7	7	5.9	5.9	6	230
235													6.4	6.4	6.4	6.5	6.5	6.5	5.6	5.6	5.6	235
240													4.6	4.8	4.3	5.9	6	6	5.2	5.2	5.2	240
245																5.3	5.3	5.3	4.9	4.8	4.8	245
250																4.4	4.6	4.3	4.4	4.4	4.4	250
255																2.1			2.8	3	2.6	255

t_240_002_56001_00_000

Lifting capacities Forces de levage

TNZK



Lifting height (ft)	48 ft			144 ft			160 ft			176 ft			192 ft			Lifting height (ft)
	0°	20°	40°	0°	20°	40°	0°	20°	40°	0°	20°	40°	0°	20°	40°	
12	52.4															12
13	52.1															13
14	51.7															14
15	51.2															15
16	50.7															16
17	50.1															17
18	49.5															18
19	48.9	39.2														19
20	48.3	39														20
22	47.1	37.2														22
24	45.8	35.3		52.7												24
26	44.3	33.6		52.8												26
28	42.9	32.1	23.1	52.8			47.4									28
30	41.4	30.8	22.8	52.6			47.4									30
32	40.1	29.5	22.1	52.4			47.4			41.7						32
34	38.8	28.5	21.6	52			47.3			41.6						34
36	37.5	27.4	21.1	51.6			47.1			41.6			35.6			36
38	36.3	26.4	20.6	51.2	38.4		46.7			41.5			35.7			38
40	34.9	25.6	20.2	50.7	37.5		46.3			41.3			35.7			40
45	31.2	23.6	19.2	49.3	35.2	23.1	45.4	36.1		40.7			35.5			45
50	28	22.1	18.4	47.8	33.3	22.3	44.5	34.1	22.5	40.1	34.5		35.2			50
55	25.4	20.8	17.8	46.3	31.6	21.7	43.5	32.3	21.9	39.5	32.9	22	34.8	31.8		55
60	23.4	19.6	17.4	44.6	30	21.1	42.6	30.8	21.3	38.8	31.3	21.4	34.4	31	21.5	60
65	21.6	18.7	17.1	42.8	28.7	20.6	41.4	29.5	20.8	38.2	29.9	20.9	34	30.1	20.9	65
70	20.1	18	17.1	41.1	27.5	20.1	40.1	28.3	20.3	37.5	28.7	20.5	33.6	28.8	20.5	70
75	18.8	17.6	16.3	39.5	26.4	19.6	38.8	27.2	19.9	36.7	27.5	20	33.1	27.7	20.1	75
80	17.8	17.5		38	25.4	19.2	37.6	26.2	19.5	35.8	26.6	19.7	32.7	26.7	19.7	80
85				36.5	24.5	18.9	36.4	25.2	19.1	34.9	25.7	19.3	32	25.8	19.4	85
90				34.8	23.6	18.6	35.2	24.4	18.8	34	24.8	19	31.4	25	19.1	90
95				33	22.9	18.3	34.1	23.6	18.5	33.1	24	18.7	30.7	24.3	18.8	95
100				31.3	22.2	18	32.9	22.9	18.2	32.3	23.3	18.4	29.9	23.5	18.5	100
105				29.6	21.5	17.8	31.4	22.3	18	31.5	22.7	18.1	29	22.9	18.2	105
110				28.2	20.9	17.6	30	21.6	17.8	30.5	22.1	17.9	27.8	22.3	18	110
115				26.9	20.4	17.4	28.6	21	17.6	29.4	21.5	17.7	26.5	21.7	17.8	115
120				25.7	19.9	17.3	27.3	20.6	17.4	28.2	21	17.5	25.4	21.1	17.6	120
125				24.6	19.4	17.2	26.3	20.1	17.3	27	20.5	17.4	24.3	20.7	17.4	125
130				23.7	19	17.1	25.2	19.6	17.1	25.9	20.1	17.2	23.2	20.3	17.3	130
135				22.8	18.6	17.1	24.2	19.2	17.1	24.7	19.7	17.2	22.2	19.9	17.2	135
140				21.9	18.3	17.1	23.3	18.9	17	23.6	19.3	17.1	21.2	19.5	17.1	140
145				21.1	18	15.7	22.6	18.6	17	22.6	18.9	17	20.2	19.1	17.1	145
150				20.4	17.8	10.1	21.8	18.2	17	21.5	18.6	17	19.3	18.7	17	150
155				19.7	17.6	7.2	21	18	16.5	20.4	18.4	17	18.4	18.3	17	155
160				19.1	17.5	5.4	20.4	17.8	12.4	19	18.1	17	17.5	17.8	16.8	160
165				18.6	17.5		19.4	17.6	8.7	17.7	17.8	17	16.7	17.1	16.6	165
170				17.2	16		18.1	17.5	6.6	17	17.1	15.1	16	16.4	16.4	170
175				10.2	6.9		17	17.4	5.1	16.3	16.5	10.5	15	15.6	15.8	175
180							15.9	16.3		15.5	15.8	7.8	14	14.7	15	180
185							13.3	15.2		14.5	15	6.1	13.1	13.6	12.2	185
190							7.7	7.5		13.6	14	4.9	12.6	12.7	9.1	190
195										12.7	13		12.1	12.2	7.2	195
200										10.4	12.1		11.6	11.7	5.8	200
205										6.1	7.8		11	11.3		205
210													10.3	10.6		210
215													8.3	9.8		215
220													7.1	7.2		220

L_240_002_56101_00_000

Lifting capacities Forces de levage

TNZK



41 ft ↙ ↘	208 ft 41 ft			224 ft 41 ft			240 ft 41 ft			253 ft 41 ft			256 ft 41 ft			41 ft ↙ ↘
	0°	20°	40°	0°	20°	40°	0°	20°	40°	0°	20°	40°	0°	20°	40°	
45	30			23.3												45
50	30.1			23.5			19.4									50
55	29.9			23.6			19.4			16.4			15.9			55
60	29.7	28.3		23.8			19.4			16.4			15.9			60
65	29.5	27.8	20.9	23.9	23.9		19.3			16.4			16			65
70	29.3	27.3	22.6	23.8	23.7		19.2	19.2		16.3			15.9			70
75	28.9	26.9	22	23.6	23.3	22.5	19.1	18.8		16.1	16		15.8	15.7		75
80	28.5	26.4	21.5	23.2	22.8	22.1	18.9	18.4	17.8	15.9	15.8		15.6	15.5		80
85	28.1	25.6	21.1	22.6	22.3	21.6	18.7	17.9	17.4	15.7	15.5	15.1	15.4	15.2	15	85
90	27.4	24.8	20.8	22.1	21.7	21.2	18.2	17.5	16.9	15.5	15.1	14.7	15.2	15	14.6	90
95	26.7	24.1	20.5	21.5	21.1	20.7	17.9	17	16.4	15.1	14.8	14.4	14.9	14.6	14.2	95
100	25.8	23.4	20.2	20.8	20.4	20.3	17.4	16.6	16	14.7	14.4	14	14.5	14.3	13.9	100
105	24.9	22.8	19.9	20.2	19.8	19.7	17	16.1	15.6	14.3	14.1	13.7	14.1	13.9	13.6	105
110	24	22.2	19.4	19.5	19.1	19.1	16.5	15.7	15.2	13.9	13.7	13.4	13.8	13.6	13.3	110
115	23.2	21.7	18.8	18.9	18.5	18.5	16.1	15.3	14.9	13.5	13.3	13	13.4	13.2	12.9	115
120	22.4	21.1	18.2	18.2	17.9	17.9	15.6	14.9	14.5	13.1	12.9	12.7	12.9	12.8	12.6	120
125	21.5	20.7	17.6	17.6	17.3	17.3	15.1	14.6	14.2	12.6	12.5	12.4	12.5	12.4	12.3	125
130	20.7	20.1	17.3	17	16.8	16.7	14.6	14.2	13.9	12.2	12.1	12.1	12.1	12	12.1	130
135	19.9	19.6	17.2	16.4	16.2	16.2	14.1	13.8	13.5	11.8	11.7	11.8	11.7	11.6	11.7	135
140	19.1	19	17.1	15.9	15.7	15.7	13.7	13.4	13.2	11.4	11.3	11.4	11.3	11.2	11.4	140
145	18.3	18.3	17.1	15.4	15.2	15.2	13.2	13	12.9	11	10.9	11	10.9	10.9	11	145
150	17.5	17.7	17	14.9	14.7	14.7	12.8	12.7	12.6	10.6	10.6	10.7	10.6	10.5	10.6	150
155	16.7	17.1	16.8	14.4	14.3	14.3	12.4	12.3	12.3	10.3	10.2	10.3	10.2	10.2	10.3	155
160	16	16.4	16.3	13.9	13.8	13.8	12	11.9	12	9.9	9.9	10	9.8	9.8	9.9	160
165	15.3	15.6	15.7	13.5	13.3	13.4	11.6	11.6	11.6	9.6	9.5	9.6	9.5	9.5	9.6	165
170	14.6	14.9	15.2	13	12.9	13	11.2	11.2	11.3	9.2	9.2	9.3	9.2	9.2	9.3	170
175	13.9	14.2	14.5	12.5	12.5	12.6	10.9	10.8	10.9	8.9	8.9	9	8.9	8.9	9	175
180	13.2	13.6	13.9	12.1	12.1	12.2	10.5	10.5	10.6	8.6	8.6	8.7	8.6	8.6	8.7	180
185	12.6	13	13.2	11.6	11.7	11.8	10.2	10.2	10.3	8.3	8.3	8.4	8.3	8.3	8.4	185
190	12	12.3	12.6	11.1	11.3	11.5	9.8	9.8	9.9	8	8	8.1	8	8	8.1	190
195	11.2	11.7	11.9	10.7	10.9	11.1	9.5	9.5	9.6	7.8	7.8	7.9	7.7	7.8	7.9	195
200	10.3	11	10.7	10.2	10.4	10.7	9.2	9.2	9.3	7.5	7.5	7.6	7.4	7.5	7.6	200
205	9.8	10.1	8.3	9.7	10	10.2	8.9	8.9	9	7.3	7.3	7.4	7.1	7.3	7.4	205
210	9.5	9.5	6.7	9.2	9.5	9.7	8.6	8.7	8.8	7.1	7	7.1	6.8	7.1	7.1	210
215	9.1	9.2	5.5	8.7	9	9.2	8.3	8.4	8.5	6.8	6.8	6.9	6.5	6.8	6.8	215
220	8.7	8.8		7.9	8.4	7.6	7.9	8.1	8.2	6.6	6.6	6.7	6.2	6.4	6.5	220
225	8.4	8.5		7.6	7.7	6.3	7.6	7.8	7.9	6.4	6.4	6.5	5.9	6.1	6.2	225
230	7	8.2		7.4	7.4	5.3	7.2	7.5	7.6	6.2	6.2	6.3	5.5	5.7	5.9	230
235	5.6	6.6		7.1	7.2		6.8	7.1	7	6	6	6.1	5.1	5.4	5.5	235
240				6.9	6.9		6.3	6.6	6	5.8	5.8	5.9	4.8	5	5.1	240
245				6.1	6.8		5.8	6.1	5.1	5.5	5.6	5.7	4.4	4.7	4.7	245
250				3.5	4.8		5.1	5.5		5.2	5.4	5.5	4.1	4.3	4.4	250
255							4.6	4.9		4.6	5	5.1	3.8	4	4	255
260							3.2	4.3		4	4.4		3.5	3.7	3.7	260
265										3.4	3.8		3.2	3.4		265
270										2.8	3.2		2.7	3		270
275														2.4		275

L_240_002_56101_00_000

Lifting capacities Forces de levage

TNZK



↙ ↘	48 ft 69 ft			144 ft 69 ft			160 ft 69 ft			176 ft 69 ft			192 ft 69 ft			↙ ↘
	0°	20°	40°	0°	20°	40°	0°	20°	40°	0°	20°	40°	0°	20°	40°	
12	20.8															12
13	20.8															13
14	20.9															14
15	21															15
16	21															16
17	21															17
18	21															18
19	21															19
20	21															20
22	21															22
24	20.9															24
26	20.7															26
28	20.5			20.8												28
30	20.3			20.9			19.9									30
32	20			21			19.9									32
34	19.7	17.8		21			19.9			18.7						34
36	19.4	17.5		21			19.9			18.7						36
38	19.1	17.2		21			19.9			18.8			17.4			38
40	18.7	16.9		21			19.9			18.8			17.4			40
45	17.9	16.1		21			19.9			18.8			17.5			45
50	17.1	15.4		20.8			19.9			18.8			17.5			50
55	16.3	14.7	13.2	20.5	17.5		19.8	17.2		18.8			17.5			55
60	15.5	14.1	12.8	20.3	17		19.6	16.8		18.7	16.3		17.5			60
65	14.8	13.6	12.4	19.9	16.7		19.3	16.4		18.5	16		17.3	15.2		65
70	14.2	13.1	12	19.5	16.2	13.4	19	16		18.2	15.6		17.1	15		70
75	13.6	12.6	11.8	19	15.8	13.2	18.6	15.6	13.1	17.9	15.3		16.8	14.7		75
80	13.1	12.3	11.6	18.6	15.4	13	18.2	15.3	12.9	17.6	15	12.7	16.6	14.4		80
85	12.6	12	11.4	18.1	15.1	12.8	17.8	15	12.7	17.2	14.7	12.5	16.3	14.2	12.2	85
90	12.1	11.7	11.4	17.7	14.7	12.6	17.4	14.6	12.5	16.9	14.4	12.3	16	13.9	12.1	90
95	11.6	11.5	11.4	17.2	14.4	12.4	17	14.3	12.3	16.5	14.1	12.2	15.7	13.7	11.9	95
100	11.1	11.4	11.4	16.7	14.1	12.2	16.6	14.1	12.2	16.2	13.9	12	15.4	13.4	11.8	100
105	10.6	11.3	4.5	16.3	13.8	12.1	16.2	13.8	12	15.8	13.6	11.9	15.1	13.2	11.7	105
110	9.8			15.9	13.5	11.9	15.8	13.5	11.9	15.5	13.4	11.7	14.9	13	11.5	110
115				15.5	13.3	11.8	15.5	13.3	11.8	15.2	13.1	11.6	14.6	12.8	11.4	115
120				15.1	13.1	11.7	15.1	13	11.6	14.9	12.9	11.5	14.4	12.6	11.3	120
125				14.7	12.8	11.6	14.8	12.8	11.5	14.6	12.7	11.4	14.1	12.4	11.2	125
130				14.4	12.6	11.5	14.4	12.6	11.4	14.3	12.5	11.4	13.9	12.3	11.1	130
135				14.1	12.4	11.4	14.1	12.4	11.4	14	12.3	11.3	13.6	12.1	11.1	135
140				13.7	12.2	11.4	13.8	12.3	11.3	13.8	12.2	11.2	13.4	11.9	11	140
145				13.4	12.1	11.4	13.6	12.1	11.3	13.5	12	11.2	13.2	11.8	11	145
150				13.1	11.9	11.4	13.3	11.9	11.2	13.2	11.9	11.1	13	11.7	10.9	150
155				12.9	11.8	11.4	13	11.8	11.2	13	11.7	11.1	12.8	11.5	10.9	155
160				12.6	11.7	11.4	12.8	11.7	11.2	12.8	11.6	11.1	12.6	11.4	10.8	160
165				12.3	11.6	11.4	12.5	11.6	11.2	12.5	11.5	11.1	12.4	11.3	10.8	165
170				12	11.5	11.4	12.3	11.5	11.2	12.3	11.4	11.1	12.2	11.2	10.8	170
175				11.8	11.5	11.4	12.1	11.4	11.2	12.1	11.3	11.1	12	11.1	10.8	175
180				11.5	11.4	8.6	11.8	11.3	11.2	12	11.2	11.1	11.8	11.1	10.8	180
185				11.2	11.3	6.2	11.6	11.3	11.2	11.8	11.2	11.1	11.7	11	10.8	185
190				10.9	11.3		11.4	11.3	10.3	11.6	11.1	11.1	11.5	10.9	10.8	190
195				10.6	11.3		11.2	11.2	7.6	11.4	11.1	11.1	11.2	10.9	10.8	195
200				10.2	10.7		11	11.2	5.8	11.3	11.1	11.1	11	10.9	10.8	200
205							10.8	11.2		11.1	11	9.1	10.7	10.9	10.8	205
210							10.5	11.2		10.9	11	7	10.1	10.6	10.8	210
215							7.7	10.6		10.7	10.9	5.4	9.4	10.2	10.3	215
220										10.1	10.7		9	9.4	8.2	220
225										8.8	9.9		8.7	8.8	6.4	225
230										6	8.1		8.3	8.5	5.2	230
235											3		8	8.2		235
240													7	7.9		240
245													5.2	6.5		245
250														5.2		250

t_240_002_56301_00_000

Lifting capacities Forces de levage

TNZK



↙ ↘	208 ft 69 ft			224 ft 69 ft			240 ft 69 ft			253 ft 69 ft			256 ft 69 ft			↙ ↘
	0°	20°	40°	0°	20°	40°	0°	20°	40°	0°	20°	40°	0°	20°	40°	
45	15.8															45
50	15.9			14												50
55	15.9			14.1			12.2									55
60	15.8			14.1			12.2			10.6			10.4			60
65	15.7			14			12.2			10.6			10.4			65
70	15.6	14.1		14			12.2			10.7			10.4			70
75	15.5	13.9		13.8			12.1			10.7			10.5			75
80	15.2	13.6		13.7	12.6		12.1			10.7			10.4			80
85	15	13.4		13.6	12.5		12	11.3		10.6			10.4			85
90	14.8	13.2	11.7	13.4	12.3		11.9	11.2		10.6	10.2		10.4	10		90
95	14.6	13	11.5	13.2	12.1	11.1	11.8	11.1		10.5	10.1		10.3	9.9		95
100	14.4	12.8	11.4	13.1	12	11	11.7	11		10.4	10.1		10.3	9.9		100
105	14.2	12.6	11.3	13	11.9	10.9	11.6	10.9	10.3	10.4	10		10.2	9.8		105
110	14	12.4	11.2	12.8	11.7	10.8	11.5	10.8	10.3	10.3	9.9	9.6	10.1	9.8	9.5	110
115	13.8	12.3	11.1	12.7	11.6	10.7	11.4	10.7	10.2	10.2	9.8	9.5	10	9.7	9.4	115
120	13.6	12.1	11	12.5	11.5	10.6	11.2	10.6	10.1	10.1	9.6	9.4	10	9.5	9.3	120
125	13.4	12	11	12.4	11.4	10.6	11.1	10.5	10.1	10	9.4	9.2	9.9	9.4	9.1	125
130	13.2	11.8	10.9	12.2	11.2	10.5	10.9	10.4	10	9.8	9.2	8.9	9.7	9.1	8.9	130
135	13	11.7	10.8	12.1	11.1	10.5	10.8	10.2	9.9	9.5	9	8.7	9.4	8.9	8.7	135
140	12.8	11.5	10.8	11.9	11	10.5	10.6	10	9.7	9.2	8.7	8.5	9.2	8.7	8.5	140
145	12.6	11.4	10.7	11.8	10.9	10.4	10.4	9.8	9.5	9	8.5	8.3	8.9	8.5	8.3	145
150	12.4	11.3	10.7	11.6	10.8	10.4	10.2	9.5	9.3	8.7	8.3	8.1	8.7	8.3	8.1	150
155	12.2	11.2	10.7	11.5	10.7	10.4	10	9.3	9.1	8.5	8.1	7.9	8.4	8.1	7.9	155
160	12.1	11.1	10.6	11.3	10.6	10.3	9.7	9.1	8.9	8.2	7.9	7.8	8.2	7.9	7.8	160
165	11.9	11	10.6	11.1	10.5	10.3	9.5	8.9	8.8	8	7.7	7.6	7.9	7.7	7.6	165
170	11.8	10.9	10.6	10.8	10.4	10.3	9.2	8.7	8.6	7.7	7.6	7.5	7.7	7.5	7.5	170
175	11.6	10.9	10.6	10.5	10.2	10.3	8.9	8.5	8.4	7.4	7.4	7.3	7.4	7.4	7.3	175
180	11.4	10.8	10.6	10.2	10	10.2	8.7	8.3	8.2	7.2	7.2	7.2	7.2	7.2	7.2	180
185	11.1	10.7	10.6	9.9	9.8	10	8.5	8.1	8.1	7	7	7	6.9	7	7	185
190	10.8	10.7	10.6	9.6	9.6	9.8	8.2	8	7.9	6.8	6.8	6.9	6.7	6.8	6.9	190
195	10.6	10.6	10.6	9.3	9.3	9.6	7.9	7.8	7.8	6.6	6.7	6.8	6.5	6.6	6.7	195
200	10.3	10.5	10.6	9.1	9.1	9.3	7.7	7.6	7.6	6.4	6.5	6.6	6.3	6.4	6.6	200
205	9.9	10.2	10.5	8.8	8.8	9	7.5	7.5	7.5	6.2	6.3	6.4	6.2	6.2	6.4	205
210	9.5	9.8	10.2	8.5	8.5	8.7	7.3	7.3	7.4	6	6.1	6.2	6	6	6.2	210
215	9.1	9.5	9.9	8.2	8.3	8.5	7.1	7.1	7.2	5.8	5.9	6	5.8	5.9	6	215
220	8.6	9.1	9.4	7.9	8	8.2	6.9	6.9	7.1	5.6	5.7	5.9	5.6	5.7	5.8	220
225	7.9	8.7	8.9	7.6	7.7	8	6.7	6.8	6.9	5.5	5.5	5.7	5.3	5.5	5.7	225
230	7.3	8.1	8.4	7.3	7.5	7.7	6.5	6.6	6.8	5.3	5.4	5.5	5	5.3	5.5	230
235	7	7.5	7.5	6.9	7.2	7.4	6.3	6.4	6.6	5.1	5.2	5.4	4.7	5.2	5.3	235
240	6.8	7	6.1	6.5	6.9	7.1	6.1	6.3	6.4	5	5	5.2	4.5	5	5.1	240
245	6.6	6.7	5	6.1	6.6	6.8	5.9	6.1	6.2	4.8	4.9	5	4.2	4.7	4.8	245
250	6.4	6.5		5.7	6.2	6.3	5.7	5.9	6.1	4.6	4.7	4.9	3.9	4.4	4.5	250
255	5.7	6.2		5.5	5.7	5.7	5.4	5.7	5.9	4.4	4.6	4.7	3.6	4.1	4.2	255
260	4.9	5.4		5.4	5.4		4.9	5.4	5.6	4.2	4.4	4.5	3.3	3.7	3.9	260
265		3.4		5.2	5.3		4.4	5.1	5.3	4	4.2	4.4	3	3.4	3.5	265
270				4.7	5.1		3.9	4.5	4.6	3.7	4	4.1	2.7	3.1	3.2	270
275				2.8	4.5		3.3	3.9		3.3	3.8	3.9	2.4	2.8	2.9	275
280							2.8	3.4		2.5	3.4	3.5		2.5	2.5	280
285								2.8			2.9	2.9				285

t_240_002_56301_00_000

Lifting heights Hauteurs de levage

TNZK

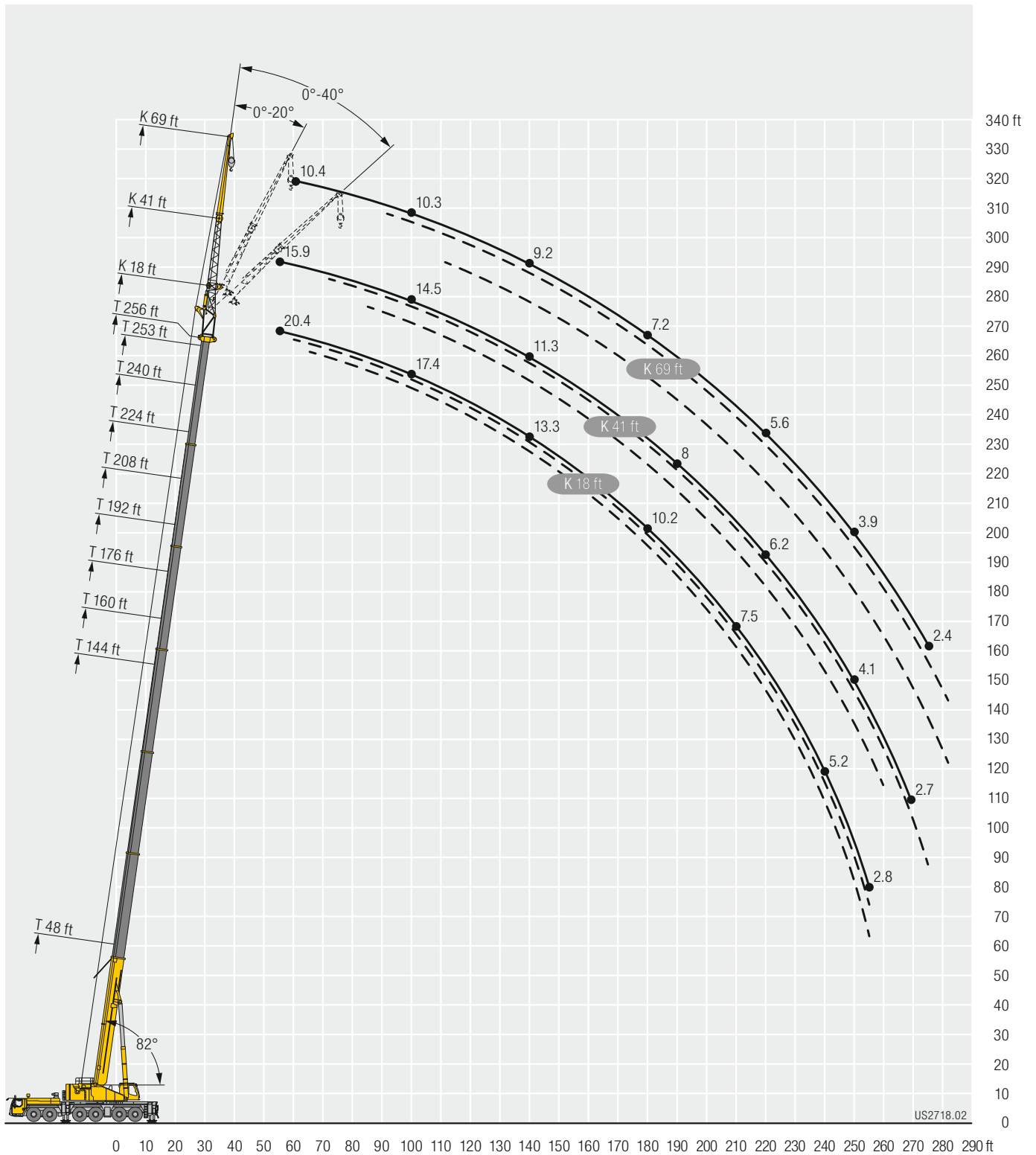

Lifting capacities Forces de levage

TNZK



↙ ↘	48 ft 64 ft			144 ft 64 ft			160 ft 64 ft			176 ft 64 ft			192 ft 64 ft			↙ ↘
	0°	20°	40°	0°	20°	40°	0°	20°	40°	0°	20°	40°	0°	20°	40°	
12	31.4															12
13	31.4															13
14	31.4															14
15	31.4															15
16	31.2															16
17	31															17
18	30.7															18
19	30.5															19
20	30.2															20
22	29.6															22
24	29															24
26	28.4															26
28	27.7			31.4												28
30	27.1			31.4			27									30
32	26.4	22.9		31.4			27									32
34	25.8	22.3		31.3			27				24.9					34
36	25.2	21.6		31.1			27				24.9					36
38	24.6	21		30.9			27				24.9		22.1			38
40	24	20.4		30.6			27				25		22.1			40
45	22.6	19.1		29.8			27				25		22.1			45
50	21.2	17.9	15.1	29	22.7		26.9				25		22.2			50
55	19.7	16.9	14.3	28.1	21.8		26.7	22.3			24.7		22.1			55
60	18.2	16	13.7	27.3	21		26.1	21.7			24.3	20.9	21.9			60
65	16.9	15.2	13.1	26.4	20.3	15.4	25.5	21.2			23.9	20.4	21.6	19.3		65
70	15.6	14.5	12.6	25.6	19.6	15	25	20.6	15.9		23.4	19.9	21.3	18.9		70
75	14.5	13.8	12.2	24.8	18.9	14.6	24.3	20.1	15.7		23	19.5	21	18.6		75
80	13.6	13.2	11.9	24	18.3	14.3	23.7	19.6	15.4		22.5	19.1	20.7	18.2	14.9	80
85	12.7	12.7	11.7	23.2	17.8	14	23.1	19.1	15.1		22.1	18.7	20.4	17.9	14.6	85
90	11.9	12.2	11.6	22.4	17.2	13.7	22.5	18.6	14.8		21.6	18.2	20	17.5	14.4	90
95	11.3	11.8	11.6	21.7	16.7	13.4	21.9	18.1	14.5		21.1	17.8	19.7	17.2	14.2	95
100	10.7	11.6	5.1	20.9	16.2	13.1	21.4	17.6	14.3		20.7	17.4	19.4	16.8	14	100
105	10.3			20.1	15.8	12.9	20.8	17.1	14.1		20.2	17	19.1	16.5	13.8	105
110				19.3	15.4	12.7	20.3	16.7	13.9		19.8	16.6	18.8	16.2	13.6	110
115				18.5	15	12.5	19.8	16.3	13.7		19.4	16.2	18.4	15.9	13.4	115
120				17.7	14.7	12.3	19.3	15.9	13.5		18.9	15.9	18.1	15.5	13.2	120
125				17	14.3	12.1	18.8	15.6	13.3		18.5	15.6	17.8	15.2	13.1	125
130				16.3	14	12	18.3	15.3	13.2		18.1	15.2	17.5	15	13	130
135				15.6	13.7	11.9	17.8	14.9	13		17.7	15	17.2	14.7	12.8	135
140				15	13.4	11.8	17.3	14.6	12.9		17.3	14.7	16.8	14.4	12.8	140
145				14.5	13.1	11.7	16.9	14.3	12.8		16.9	14.4	16.5	14.2	12.7	145
150				14	12.9	11.7	16.4	14	12.8		16.5	14.1	16.2	14	12.6	150
155				13.5	12.6	11.6	15.9	13.8	12.7		16.1	13.9	15.8	13.7	12.5	155
160				13	12.3	11.6	15.4	13.5	12.6		15.7	13.6	15.5	13.5	12.5	160
165				12.5	12.1	11.6	14.9	13.3	12.6		15.3	13.3	15.1	13.3	12.4	165
170				12.1	12	11.6	14.4	13	12.6		14.9	13.1	14.7	13.1	12.4	170
175				11.8	11.8	8.6	13.9	12.8	12.6		14.5	12.9	14.2	12.9	12.3	175
180				11.4	11.7	6.3	13.5	12.6	12.6		14.1	12.7	13.8	12.7	12.3	180
185				11.1	11.6		13.1	12.5	10.6		13.7	12.5	13.3	12.5	12.3	185
190				10.8	11.6		12.7	12.3	7.6		13.3	12.4	12.7	12.2	12.3	190
195				10.5	11.1		12.3	12.3	5.8		12.8	12.3	12.2	12	12.3	195
200							12	12.2			12.4	12.2	11.3	11.8	12	200
205							11.5	12.2			11.9	11.9	10.5	11.4	11.6	205
210							8.2	10.9			11.2	11.5	9.7	10.6	10.6	210
215								3.8			10.5	11	9.4	9.7	8.2	215
220											9.3	10.2	9	9.2	6.5	220
225											6.3	8.4	8.7	8.8	5.2	225
230												3.4	8.3	8.5		230
235													7.4	8.1		235
240													5.4	6.8		240
245													4.1	5.4		245

t_240_002_56201_00_000

Lifting capacities Forces de levage

TNZK



↙ ↘	208 ft 64 ft			224 ft 64 ft			240 ft 64 ft			253 ft 64 ft			256 ft 64 ft			↙ ↘
	0°	20°	40°	0°	20°	40°	0°	20°	40°	0°	20°	40°	0°	20°	40°	
45	19.2															45
50	19.2			16.4												50
55	19.3			16.4			13.8									55
60	19.2			16.4			13.9			11.9			11.6			60
65	19.1			16.4			13.9			11.9			11.6			65
70	18.9	17.5		16.4			13.9			12			11.7			70
75	18.7	17.2		16.3	15.5		13.9			12			11.7			75
80	18.5	17		16.2	15.4		13.8			11.8			11.6			80
85	18.3	16.7	14.2	16	15.2		13.7	13.2		11.7			11.5			85
90	18.1	16.5	14	15.9	15.1		13.6	13.2		11.6	11.2		11.4	10.9		90
95	17.9	16.2	13.8	15.7	14.9	13.1	13.5	13.1		11.5	11.2		11.3	10.9		95
100	17.7	15.9	13.6	15.6	14.8	13	13.3	12.9	12.1	11.4	11.1		11.2	10.8		100
105	17.4	15.7	13.4	15.4	14.6	12.9	13.2	12.6	12	11.2	10.9	10.5	11.1	10.7	10.4	105
110	17.2	15.4	13.2	15.2	14.4	12.7	13	12.2	11.7	11.1	10.6	10.2	10.9	10.5	10.2	110
115	17	15.2	13.1	15	14.2	12.6	12.8	11.9	11.4	10.9	10.3	10	10.7	10.2	9.9	115
120	16.8	14.9	13	14.8	14	12.5	12.5	11.6	11.2	10.7	10.1	9.7	10.6	10	9.7	120
125	16.6	14.7	12.8	14.6	13.8	12.4	12.2	11.3	10.9	10.5	9.8	9.5	10.4	9.7	9.4	125
130	16.3	14.4	12.7	14.3	13.6	12.3	11.8	11	10.6	10.2	9.6	9.3	10.1	9.5	9.2	130
135	16.1	14.2	12.6	14	13.4	12.2	11.5	10.7	10.4	9.9	9.3	9	9.8	9.2	9	135
140	15.9	14	12.5	13.7	13.2	12.2	11.2	10.5	10.1	9.6	9.1	8.8	9.5	9	8.8	140
145	15.6	13.8	12.4	13.2	12.9	12.1	10.9	10.2	9.9	9.3	8.9	8.6	9.2	8.8	8.6	145
150	15.2	13.6	12.4	12.8	12.6	12	10.6	9.9	9.7	9	8.6	8.4	8.9	8.6	8.4	150
155	14.8	13.4	12.3	12.4	12.2	11.9	10.4	9.7	9.5	8.7	8.4	8.2	8.6	8.4	8.2	155
160	14.3	13.1	12.2	12	11.8	11.7	10.1	9.5	9.2	8.4	8.2	8	8.3	8.2	8	160
165	13.9	12.9	12.2	11.6	11.5	11.5	9.8	9.2	9	8.1	8	7.8	8.1	7.9	7.8	165
170	13.4	12.7	12.1	11.2	11.1	11.2	9.5	9	8.9	7.8	7.8	7.7	7.8	7.7	7.7	170
175	13	12.5	12.1	10.9	10.8	10.9	9.2	8.8	8.7	7.5	7.5	7.5	7.5	7.5	7.5	175
180	12.5	12.2	12	10.5	10.5	10.6	9	8.6	8.5	7.2	7.3	7.3	7.2	7.3	7.3	180
185	12	11.9	11.9	10.1	10.1	10.3	8.7	8.4	8.3	7	7.1	7.2	7	7.1	7.1	185
190	11.4	11.6	11.7	9.8	9.8	10	8.4	8.2	8.2	6.8	6.9	7	6.8	6.9	7	190
195	10.9	11.3	11.6	9.5	9.5	9.7	8.1	8	8	6.6	6.7	6.8	6.6	6.7	6.8	195
200	10.4	10.9	11.1	9.2	9.2	9.4	7.8	7.9	7.9	6.4	6.5	6.6	6.4	6.5	6.6	200
205	10	10.4	10.7	8.9	8.9	9.1	7.6	7.6	7.7	6.2	6.3	6.4	6.2	6.3	6.4	205
210	9.5	9.9	10.2	8.6	8.6	8.8	7.4	7.4	7.5	6	6.1	6.2	6	6.1	6.2	210
215	8.9	9.5	9.7	8.3	8.3	8.6	7.2	7.2	7.3	5.8	5.9	6	5.8	5.9	6	215
220	8.3	9	9.2	7.9	8	8.3	7	7	7.1	5.7	5.7	5.9	5.5	5.7	5.9	220
225	7.6	8.4	8.6	7.6	7.7	8	6.7	6.8	6.9	5.5	5.5	5.7	5.2	5.5	5.7	225
230	7.3	7.7	7.5	7.2	7.4	7.7	6.5	6.6	6.8	5.3	5.4	5.5	4.9	5.3	5.5	230
235	7	7.1	6.1	6.8	7.1	7.3	6.3	6.4	6.6	5.2	5.2	5.3	4.6	5.1	5.3	235
240	6.8	6.9	5	6.3	6.8	7	6.1	6.3	6.4	5	5	5.2	4.3	4.8	5	240
245	6.6	6.6		5.9	6.3	6.5	5.8	6.1	6.2	4.8	4.9	5	4.1	4.5	4.7	245
250	6	6.4		5.7	5.8	5.8	5.6	5.9	6.1	4.6	4.7	4.9	3.8	4.2	4.4	250
255	5	5.6		5.5	5.6		5.1	5.6	5.8	4.4	4.6	4.7	3.5	3.8	4	255
260		3.6		5.4	5.4		4.6	5.3	5.4	4.1	4.4	4.5	3.2	3.5	3.7	260
265				4.9	5.3		4	4.7	4.8	3.8	4.1	4.3	2.9	3.2	3.3	265
270				3	4.6		3.5	4.1		3.3	3.9	4	2.6	2.9	3	270
275							3	3.5			3.5	3.6		2.6	2.6	275
280								2.9			2.5	2.6				280

L_240_002_56201_00_000

Lifting capacities Forces de levage

TNZK



↙ ↘	48 ft 87 ft			144 ft 87 ft			160 ft 87 ft			176 ft 87 ft			192 ft 87 ft			↙ ↘
	0°	20°	40°	0°	20°	40°	0°	20°	40°	0°	20°	40°	0°	20°	40°	
14	19.4															14
15	19.4															15
16	19.4															16
17	19.4															17
18	19.4															18
19	19.5															19
20	19.4															20
22	19.3															22
24	19.1															24
26	18.9															26
28	18.5															28
30	18.2															30
32	17.8			19.4												32
34	17.5			19.4			18									34
36	17.1			19.5			18.1									36
38	16.8			19.5			18.1			16.5						38
40	16.4			19.4			18.1			16.6						40
45	15.6	13.5		19.2			18.1			16.6			14.9			45
50	14.8	12.7		18.8			17.8			16.5			15			50
55	14	11.9		18.3			17.5			16.4			14.9			55
60	13.1	11.2		17.8			17			16.1			14.7			60
65	12.4	10.6	8.9	17.2	13.4		16.6	13.1		15.7			14.5			65
70	11.6	10	8.5	16.7	12.9		16.2	12.7		15.4	12.4		14.3			70
75	10.9	9.5	8.1	16.2	12.4		15.8	12.3		15	12		14	11.6		75
80	10.3	9	7.8	15.7	12		15.3	11.9		14.7	11.7		13.7	11.3		80
85	9.7	8.5	7.5	15.2	11.5	8.7	14.9	11.5		14.3	11.3		13.4	11		85
90	9.1	8.2	7.3	14.8	11.1	8.5	14.5	11.1	8.5	14	11	8.4	13.2	10.7		90
95	8.6	7.8	7.1	14.3	10.8	8.3	14.1	10.8	8.3	13.6	10.7	8.2	12.9	10.4	8	95
100	8.2	7.5	6.9	13.8	10.5	8.1	13.7	10.5	8.1	13.3	10.4	8	12.6	10.1	7.9	100
105	7.8	7.3	6.8	13.3	10.1	8	13.3	10.2	7.9	13	10.1	7.9	12.3	9.8	7.8	105
110	7.3	7	6.8	12.9	9.8	7.8	12.9	9.9	7.8	12.6	9.8	7.7	12.1	9.6	7.6	110
115	7	6.9	6.8	12.4	9.5	7.6	12.5	9.6	7.6	12.3	9.6	7.6	11.8	9.3	7.5	115
120	6.7	6.8	6.8	12	9.3	7.5	12.1	9.3	7.5	12	9.3	7.5	11.5	9.1	7.4	120
125	6.5	6.8		11.5	9	7.4	11.7	9.1	7.4	11.6	9	7.3	11.3	8.9	7.3	125
130				11.1	8.8	7.3	11.4	8.8	7.3	11.3	8.8	7.2	11	8.7	7.2	130
135				10.7	8.5	7.2	11	8.6	7.2	11	8.6	7.1	10.7	8.5	7.1	135
140				10.3	8.3	7.1	10.6	8.4	7.1	10.7	8.4	7	10.4	8.3	7	140
145				10	8.1	7	10.2	8.2	7	10.4	8.2	7	10.2	8.2	6.9	145
150				9.6	7.9	6.9	9.9	8	6.9	10.1	8.1	6.9	9.9	8	6.8	150
155				9.3	7.8	6.9	9.6	7.9	6.9	9.8	7.9	6.8	9.7	7.8	6.8	155
160				9	7.6	6.8	9.3	7.7	6.8	9.5	7.7	6.8	9.4	7.7	6.7	160
165				8.8	7.4	6.8	9	7.6	6.8	9.2	7.6	6.7	9.2	7.5	6.7	165
170				8.5	7.3	6.8	8.8	7.4	6.8	9	7.4	6.7	8.9	7.4	6.6	170
175				8.2	7.2	6.8	8.5	7.3	6.7	8.7	7.3	6.7	8.7	7.3	6.6	175
180				7.9	7.1	6.8	8.3	7.2	6.7	8.5	7.2	6.6	8.5	7.2	6.6	180
185				7.7	7	6.8	8.1	7.1	6.7	8.2	7.1	6.6	8.3	7.1	6.6	185
190				7.5	6.9	6.8	7.9	7	6.7	8	7	6.6	8.1	7	6.5	190
195				7.2	6.9	6.8	7.6	6.9	6.7	7.9	6.9	6.6	7.9	6.9	6.5	195
200				7	6.8	6.8	7.4	6.8	6.7	7.7	6.9	6.6	7.7	6.8	6.5	200
205				6.9	6.8	5.4	7.3	6.8	6.7	7.5	6.8	6.6	7.6	6.8	6.5	205
210				6.7	6.8		7.1	6.8	6.7	7.4	6.7	6.6	7.5	6.7	6.5	210
215				6.6	6.8		6.9	6.8	6.5	7.2	6.7	6.6	7.3	6.7	6.5	215
220				6.1	6.8		6.8	6.8	5.1	7.1	6.7	6.6	7.2	6.6	6.5	220
225							6.6	6.8		6.9	6.7	6.6	7.1	6.6	6.5	225
230							6.5	6.8		6.8	6.6	6.2	6.9	6.6	6.5	230
235							4.4	6.6		6.6	6.6		6.8	6.6	6.5	235
240										6.6	6.6		6.7	6.6	6.5	240
245										5.7	6.6		6.6	6.6	5.9	245
250										2.8	5.1		6.5	6.5		250
255													6.2	6.4		255
260													4.4	6.2		260
265													3.9	4		265

t_240_002_56401_00_000

Lifting capacities Forces de levage

TNZK



↙ ↘	208 ft 87 ft			224 ft 87 ft			240 ft 87 ft			253 ft 87 ft			256 ft 87 ft			↙ ↘
	0°	20°	40°	0°	20°	40°	0°	20°	40°	0°	20°	40°	0°	20°	40°	
50	13.1															50
55	13.1			11.2												55
60	13.1			11.3			9.4									60
65	13			11.3			9.5			7.8			7.5			65
70	12.9			11.2			9.5			8.1			7.8			70
75	12.7			11.1			9.5			8.2			7.9			75
80	12.5	10.6		11			9.5			8.2			7.9			80
85	12.3	10.4		10.9			9.4			8.1			7.9			85
90	12.1	10.1		10.8	9.4		9.3			8			7.8			90
95	11.9	9.9		10.6	9.2		9.2	8.4		7.9			7.7			95
100	11.7	9.7		10.5	9		9.1	8.3		7.8	7.4		7.7			100
105	11.4	9.4	7.6	10.3	8.8		9	8.1		7.8	7.3		7.6	7.3		105
110	11.2	9.2	7.4	10.2	8.7	7.1	8.9	8		7.7	7.3		7.6	7.3		110
115	11	9	7.3	10	8.5	7.1	8.8	7.9	6.7	7.7	7.3		7.5	7.2		115
120	10.8	8.8	7.2	9.9	8.4	7	8.7	7.7	6.7	7.6	7.2		7.5	7.1		120
125	10.6	8.6	7.1	9.7	8.2	6.9	8.6	7.6	6.7	7.6	7.1	6.4	7.5	7	6.4	125
130	10.4	8.5	7	9.6	8	6.8	8.5	7.5	6.6	7.6	7	6.4	7.4	6.9	6.3	130
135	10.2	8.3	7	9.4	7.9	6.8	8.4	7.4	6.5	7.5	6.9	6.3	7.4	6.9	6.3	135
140	10	8.1	6.9	9.3	7.8	6.7	8.3	7.3	6.5	7.4	6.8	6.3	7.2	6.8	6.2	140
145	9.8	8	6.8	9.1	7.6	6.7	8.2	7.2	6.4	7.2	6.8	6.2	7.1	6.7	6.2	145
150	9.5	7.8	6.7	9	7.5	6.6	8.1	7.1	6.4	7.1	6.7	6.2	7	6.6	6.2	150
155	9.3	7.7	6.7	8.8	7.4	6.5	8	7	6.4	6.9	6.6	6.1	6.9	6.5	6.1	155
160	9.1	7.5	6.6	8.6	7.3	6.5	7.8	6.9	6.3	6.8	6.4	6.1	6.7	6.4	6.1	160
165	8.9	7.4	6.6	8.5	7.2	6.5	7.6	6.8	6.3	6.7	6.3	6	6.6	6.3	6	165
170	8.7	7.3	6.5	8.3	7.1	6.4	7.4	6.7	6.2	6.5	6.2	6	6.4	6.1	5.9	170
175	8.5	7.2	6.5	8.1	7	6.4	7.3	6.7	6.2	6.3	6	5.9	6.3	6	5.9	175
180	8.3	7.1	6.5	8	6.9	6.4	7.1	6.6	6.2	6.1	5.9	5.8	6.1	5.9	5.8	180
185	8.1	7	6.4	7.8	6.8	6.3	6.9	6.5	6.2	6	5.7	5.7	5.9	5.7	5.7	185
190	8	6.9	6.4	7.7	6.7	6.3	6.8	6.4	6.2	5.8	5.6	5.6	5.7	5.6	5.5	190
195	7.8	6.8	6.4	7.5	6.7	6.3	6.6	6.3	6.1	5.6	5.5	5.5	5.5	5.5	5.4	195
200	7.7	6.7	6.4	7.4	6.6	6.3	6.5	6.2	6.1	5.4	5.4	5.4	5.3	5.4	5.3	200
205	7.5	6.7	6.4	7.2	6.5	6.3	6.3	6	6	5.2	5.3	5.3	5.2	5.3	5.2	205
210	7.4	6.6	6.4	7.1	6.5	6.3	6.2	5.9	5.9	5	5.1	5.2	5	5.1	5.2	210
215	7.2	6.6	6.4	6.9	6.5	6.3	6.1	5.8	5.8	4.8	5	5.1	4.8	5	5.1	215
220	7.1	6.5	6.4	6.8	6.4	6.3	5.9	5.7	5.7	4.6	4.8	5	4.6	4.8	4.9	220
225	6.9	6.5	6.4	6.6	6.4	6.3	5.8	5.6	5.6	4.5	4.7	4.8	4.5	4.7	4.8	225
230	6.8	6.5	6.4	6.5	6.3	6.3	5.6	5.5	5.6	4.3	4.5	4.7	4.3	4.5	4.7	230
235	6.7	6.4	6.4	6.3	6.2	6.3	5.4	5.4	5.5	4.1	4.3	4.6	4.1	4.3	4.6	235
240	6.4	6.4	6.4	6	6.1	6.3	5.3	5.3	5.4	3.9	4.2	4.4	3.8	4.1	4.4	240
245	6	6.3	6.4	5.8	6	6.2	5.1	5.2	5.3	3.8	4	4.3	3.6	4	4.3	245
250	5.6	6.1	6.4	5.5	5.8	6.1	4.9	5	5.2	3.6	3.9	4.1	3.3	3.8	4.1	250
255	5.4	5.8	6	5.1	5.6	5.8	4.7	4.9	5.1	3.5	3.7	3.9	3	3.6	3.9	255
260	5.2	5.4	5.5	4.6	5.4	5.5	4.5	4.8	4.9	3.3	3.6	3.8	2.8	3.3	3.7	260
265	5.1	5.2		4.4	5	5.2	4.2	4.6	4.8	3.1	3.4	3.6		3.1	3.3	265
270	4.9	5		4.2	4.4	4.6	3.9	4.5	4.6		3.2	3.4		2.8	3	270
275	3.7	4.8		4.1	4.2	4.4	3.4	4.2	4.4		3	3.2		2.5	2.7	275
280		3.6		4	4.1		2.8	3.8	4		2.8	3			2.3	280
285				3.8	3.9			3.3	3.4			2.6				285
290				2.3	3.8			2.4	2.5							290

t_240_002_56401_00_000

Lifting heights Hauteurs de levage

TNZK

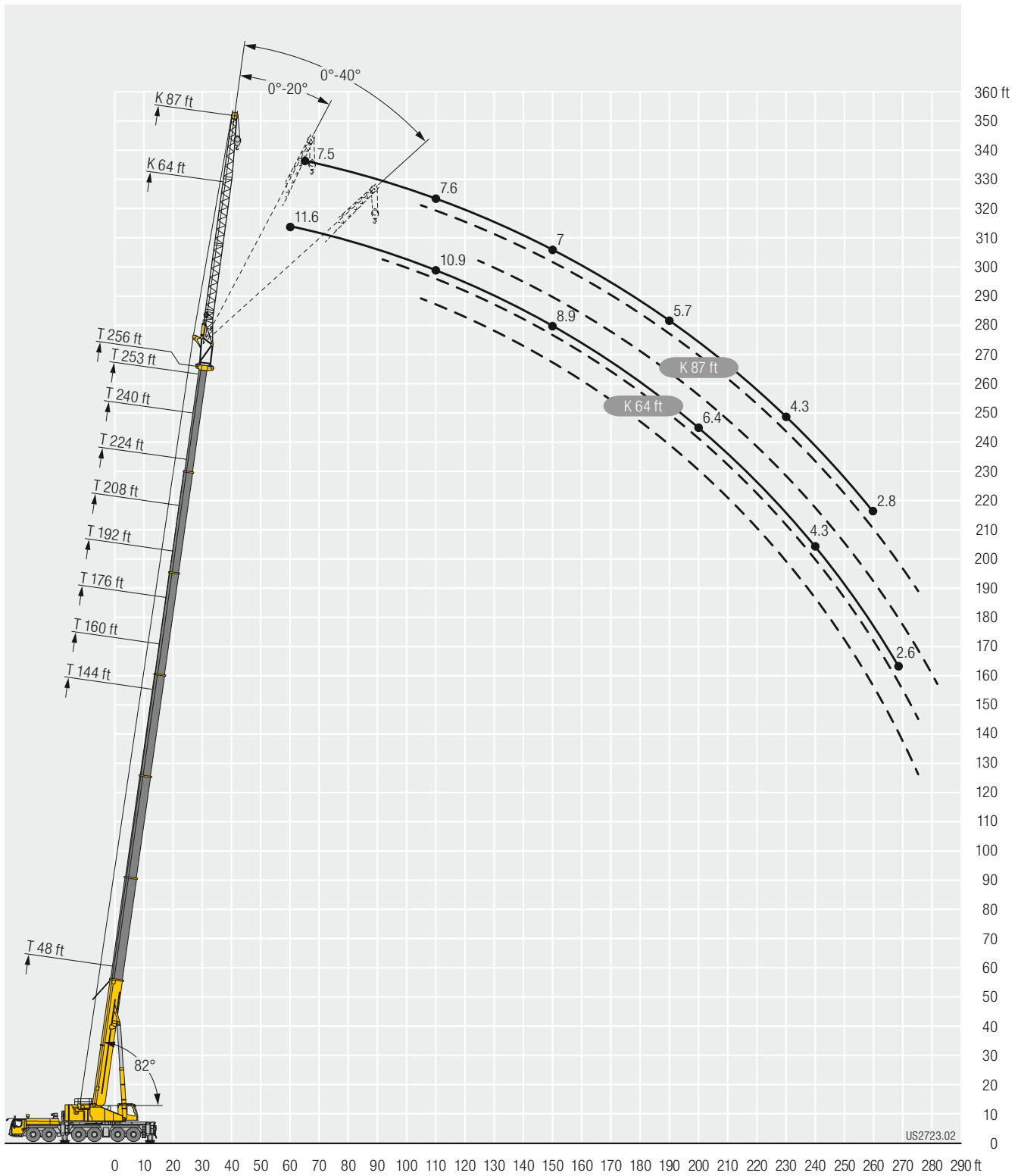

Lifting capacities Forces de levage

TNZK



↙ ↘	48 ft 92 ft			144 ft 92 ft			160 ft 92 ft			176 ft 92 ft			192 ft 92 ft			↙ ↘
	0°	20°	40°	0°	20°	40°	0°	20°	40°	0°	20°	40°	0°	20°	40°	
15	15.9															15
16	15.9															16
17	15.9															17
18	15.9															18
19	15.9															19
20	16															20
22	15.9															22
24	15.9															24
26	15.8															26
28	15.6															28
30	15.4															30
32	15.2			15.4												32
34	15			15.8												34
36	14.8			15.9			14.9									36
38	14.5			16			15.1									38
40	14.3			15.9			15.2			14.1						40
45	13.7			15.9			15.2			14.2			12.9			45
50	13.1	11.6		15.7			15			14.2			13			50
55	12.5	10.9		15.4			14.8			14			13			55
60	11.9	10.3		15.1			14.6			13.8			12.9			60
65	11.2	9.7		14.8	12		14.3			13.6			12.7			65
70	10.6	9.2	7.8	14.4	11.6		14	11.5		13.3			12.5			70
75	10.1	8.8	7.5	14.1	11.2		13.7	11.1		13.1	10.9		12.3			75
80	9.5	8.3	7.2	13.7	10.8		13.4	10.7		12.8	10.5		12.1	10.2		80
85	9	8	7	13.4	10.5		13.1	10.4		12.6	10.2		11.9	9.9		85
90	8.5	7.6	6.8	13	10.1	7.8	12.8	10.1	7.8	12.3	9.9		11.6	9.7		90
95	8.1	7.3	6.7	12.6	9.8	7.6	12.5	9.8	7.6	12.1	9.7	7.5	11.4	9.4		95
100	7.7	7	6.5	12.3	9.5	7.5	12.2	9.5	7.4	11.8	9.4	7.4	11.2	9.2	7.2	100
105	7.3	6.8	6.4	11.9	9.2	7.3	11.9	9.3	7.3	11.5	9.1	7.2	11	8.9	7.1	105
110	7	6.6	6.3	11.5	9	7.2	11.5	9	7.2	11.3	8.9	7.1	10.8	8.7	7	110
115	6.7	6.5	6.3	11.2	8.7	7.1	11.2	8.8	7.1	11	8.7	7	10.6	8.5	6.9	115
120	6.5	6.4	6.3	10.8	8.5	7	10.9	8.5	6.9	10.7	8.5	6.9	10.4	8.3	6.8	120
125	6.2	6.3	6.3	10.5	8.2	6.9	10.6	8.3	6.8	10.4	8.3	6.8	10.1	8.1	6.7	125
130	6	6.3		10.1	8	6.8	10.3	8.1	6.7	10.2	8.1	6.7	9.9	8	6.6	130
135				9.8	7.8	6.7	9.9	7.9	6.7	9.9	7.9	6.6	9.7	7.8	6.6	135
140				9.4	7.6	6.6	9.7	7.7	6.6	9.7	7.7	6.6	9.4	7.6	6.5	140
145				9.1	7.4	6.5	9.3	7.5	6.5	9.4	7.5	6.5	9.2	7.5	6.4	145
150				8.8	7.3	6.5	9.1	7.4	6.4	9.1	7.4	6.4	9	7.3	6.4	150
155				8.5	7.2	6.4	8.8	7.2	6.4	8.9	7.3	6.4	8.8	7.2	6.3	155
160				8.3	7	6.4	8.6	7.1	6.3	8.6	7.1	6.3	8.6	7	6.3	160
165				8	6.9	6.3	8.3	7	6.3	8.4	7	6.2	8.4	6.9	6.2	165
170				7.8	6.8	6.3	8.1	6.9	6.3	8.2	6.9	6.2	8.2	6.8	6.1	170
175				7.6	6.7	6.3	7.8	6.7	6.2	8	6.8	6.2	7.9	6.7	6.1	175
180				7.4	6.6	6.3	7.6	6.7	6.2	7.8	6.7	6.1	7.8	6.6	6.1	180
185				7.2	6.5	6.3	7.5	6.6	6.2	7.6	6.6	6.1	7.6	6.6	6.1	185
190				7	6.4	6.3	7.3	6.5	6.2	7.4	6.5	6.1	7.4	6.5	6	190
195				6.8	6.4	6.3	7.1	6.4	6.2	7.2	6.4	6.1	7.3	6.4	6	195
200				6.7	6.3	6.3	7	6.4	6.2	7.1	6.4	6.1	7.1	6.4	6	200
205				6.5	6.3	6.3	6.8	6.3	6.2	7	6.3	6.1	7	6.3	6	205
210				6.4	6.3	5.4	6.7	6.3	6.2	6.8	6.3	6.1	6.9	6.2	6	210
215				6.2	6.3		6.6	6.2	6.2	6.7	6.2	6.1	6.8	6.2	6	215
220				6.1	6.3		6.4	6.2	6.2	6.6	6.2	6.1	6.7	6.1	6	220
225				5.7	6.3		6.3	6.2	5.1	6.5	6.2	6.1	6.6	6.1	6	225
230							6.2	6.2		6.4	6.2	6.1	6.5	6.1	6	230
235							6.1	6.2		6.3	6.2	6	6.4	6.1	6	235
240							4.1	6.2		6.2	6.2		6.3	6.1	6	240
245										6.1	6.2		6.2	6.1	6	245
250										5.4	6.2		6.1	6.1	5.7	250
255										2.6	4.9		6	6		255
260													5.9	6		260
265													4.1	6		265
270													3.8	3.9		270

t_240_002_56501_00_000

Lifting capacities Forces de levage

TNZK



↙ ↘	208 ft			224 ft			240 ft			253 ft			256 ft			↙ ↘
	92 ft			92 ft			92 ft			92 ft			92 ft			
	0°	20°	40°	0°	20°	40°	0°	20°	40°	0°	20°	40°	0°	20°	40°	
50	11.5															50
55	11.5			9.9												55
60	11.5			10.1			8.2									60
65	11.5			10.2			8.5			6.9						65
70	11.4			10.1			8.7			7.2			6.9			70
75	11.2			10			8.7			7.4			7.2			75
80	11.1			9.9			8.6			7.5			7.3			80
85	10.9	9.4		9.8			8.5			7.5			7.4			85
90	10.7	9.2		9.7	8.5		8.4			7.5			7.3			90
95	10.6	9		9.6	8.4		8.4			7.4			7.3			95
100	10.4	8.8		9.4	8.2		8.3	7.5		7.4			7.3			100
105	10.3	8.6		9.3	8.1		8.2	7.4		7.3	6.9		7.2	6.8		105
110	10.1	8.4	6.9	9.2	7.9		8.1	7.3		7.3	6.8		7.2	6.8		110
115	9.9	8.2	6.8	9.1	7.7	6.6	8	7.2		7.2	6.8		7.1	6.7		115
120	9.7	8	6.7	8.9	7.6	6.5	7.9	7.1	6.2	7.2	6.7		7	6.6		120
125	9.6	7.9	6.6	8.8	7.5	6.4	7.8	7	6.2	7.1	6.6		7	6.5		125
130	9.4	7.7	6.5	8.7	7.3	6.3	7.7	6.9	6.1	7	6.5	5.9	6.9	6.5	5.8	130
135	9.2	7.6	6.4	8.6	7.2	6.3	7.7	6.8	6.1	7	6.4	5.9	6.9	6.4	5.8	135
140	9	7.4	6.4	8.4	7.1	6.2	7.6	6.7	6	6.9	6.4	5.8	6.8	6.3	5.8	140
145	8.8	7.3	6.3	8.3	7	6.2	7.5	6.6	6	6.8	6.3	5.8	6.7	6.2	5.8	145
150	8.7	7.1	6.3	8.1	6.9	6.1	7.4	6.6	5.9	6.7	6.2	5.7	6.6	6.2	5.7	150
155	8.5	7	6.2	8	6.8	6.1	7.3	6.5	5.9	6.6	6.2	5.7	6.5	6.1	5.7	155
160	8.3	6.9	6.2	7.9	6.7	6	7.2	6.4	5.9	6.5	6.1	5.7	6.4	6.1	5.7	160
165	8.1	6.8	6.1	7.7	6.6	6	7.1	6.3	5.8	6.4	6	5.7	6.4	6	5.6	165
170	7.9	6.7	6.1	7.6	6.5	5.9	7	6.3	5.8	6.3	5.9	5.6	6.2	5.9	5.6	170
175	7.8	6.7	6	7.4	6.4	5.9	6.9	6.2	5.8	6.2	5.8	5.6	6.1	5.8	5.6	175
180	7.6	6.6	6	7.3	6.4	5.9	6.8	6.1	5.7	6	5.7	5.6	6	5.7	5.6	180
185	7.4	6.5	6	7.2	6.3	5.9	6.7	6.1	5.7	5.8	5.6	5.5	5.8	5.6	5.5	185
190	7.3	6.4	5.9	7.1	6.2	5.8	6.6	6	5.7	5.7	5.5	5.4	5.6	5.5	5.4	190
195	7.1	6.3	5.9	7	6.2	5.8	6.5	6	5.7	5.5	5.4	5.3	5.5	5.4	5.3	195
200	7	6.3	5.9	6.8	6.1	5.8	6.3	5.9	5.7	5.3	5.3	5.3	5.3	5.3	5.2	200
205	6.9	6.2	5.9	6.7	6.1	5.8	6.2	5.8	5.7	5.1	5.2	5.2	5.1	5.1	5.2	205
210	6.8	6.2	5.9	6.6	6	5.8	6.1	5.7	5.7	5	5	5.1	4.9	5	5.1	210
215	6.7	6.1	5.9	6.5	6	5.8	5.9	5.6	5.6	4.8	4.9	5	4.8	4.9	5	215
220	6.6	6	5.9	6.5	5.9	5.8	5.8	5.5	5.6	4.6	4.8	4.9	4.6	4.7	4.9	220
225	6.5	6	5.9	6.4	5.9	5.8	5.7	5.5	5.5	4.5	4.6	4.8	4.4	4.6	4.8	225
230	6.4	6	5.9	6.3	5.9	5.8	5.5	5.4	5.4	4.3	4.5	4.7	4.3	4.5	4.7	230
235	6.4	6	5.9	6.2	5.8	5.8	5.4	5.3	5.4	4.1	4.3	4.6	4.1	4.3	4.6	235
240	6.3	5.9	5.9	6	5.8	5.8	5.2	5.2	5.3	4	4.2	4.5	3.9	4.1	4.4	240
245	6.1	5.9	5.9	5.8	5.7	5.8	5.1	5.1	5.2	3.8	4	4.3	3.7	4	4.3	245
250	5.8	5.9	5.9	5.6	5.7	5.8	4.9	5	5.1	3.7	3.9	4.1	3.4	3.8	4.1	250
255	5.4	5.8	5.9	5.3	5.6	5.8	4.7	4.9	5	3.5	3.7	4	3.2	3.6	4	255
260	5.3	5.6	5.8	4.9	5.5	5.7	4.5	4.7	4.9	3.3	3.6	3.8	2.9	3.4	3.8	260
265	5.1	5.2	5.3	4.4	5.2	5.4	4.3	4.6	4.8	3.2	3.4	3.6	2.6	3.2	3.5	265
270	4.9	5.1		4.2	4.8	5	4.1	4.5	4.6	3	3.3	3.5	2.4	3	3.2	270
275	4.7	4.9		4.1	4.2	4.4	3.7	4.3	4.4	2.7	3.1	3.3		2.7	2.9	275
280	3.6	4.7		3.9	4.1	4.2	3.2	4.1	4.2		2.9	3.1		2.4	2.5	280
285		3.5		3.8	4		2.8	3.7	3.8		2.8	3			2.2	285
290				3.6	3.8		2.1	3.1	3.3			2.7				290
295					3.6			2.6	2.7							295

t_240_002_56501_00_000

Lifting capacities Forces de levage

TNZK



↙ ↘	48 ft			144 ft			160 ft			176 ft			192 ft			↙ ↘	
	0°	20°	40°	0°	20°	40°	0°	20°	40°	0°	20°	40°	0°	20°	40°		
19	9.1															19	
20	9.1															20	
22	9.2															22	
24	10.1															24	
26	10.8															26	
28	11.2															28	
30	11.1															30	
32	10.9															32	
34	10.8															34	
36	10.6				9.3											36	
38	10.5				9.7											38	
40	10.3				10			9.1								40	
45	9.9				10.7			9.8			8.7					45	
50	9.5				11			10.3			9.2			7.8		50	
55	9				10.9			10.4			9.6			8.3		55	
60	8.6	7.4			10.7			10.2			9.7			8.7		60	
65	8.2	7			10.4			10			9.5			8.8		65	
70	7.7	6.6			10.2			9.8			9.4			8.7		70	
75	7.2	6.3			9.9			9.6			9.2			8.6		75	
80	6.8	6			9.7	7.3		9.4	7.2		9			8.4		80	
85	6.5	5.7			9.4	7.1		9.2	7		8.8	6.9		8.2		85	
90	6.1	5.5	4.8		9.1	6.9		8.9	6.8		8.6	6.7		8.1	6.4	90	
95	5.8	5.2	4.6		8.8	6.6		8.7	6.6		8.4	6.5		7.9	6.3	95	
100	5.6	5	4.5		8.6	6.4		8.4	6.4		8.2	6.3		7.7	6.2	100	
105	5.3	4.8	4.3		8.3	6.2	4.6	8.2	6.2		7.9	6.1		7.5	6	105	
110	5.1	4.6	4.2		8	6.1	4.5	7.9	6	4.5	7.7	6		7.4	5.8	110	
115	4.9	4.4	4.1		7.7	5.9	4.5	7.7	5.9	4.5	7.5	5.8	4.4	7.2	5.7	115	
120	4.7	4.3	3.9		7.4	5.7	4.4	7.4	5.7	4.4	7.3	5.7	4.3	7	5.6	4.3	120
125	4.5	4.1	3.9		7.1	5.6	4.4	7.2	5.6	4.3	7.1	5.5	4.3	6.8	5.4	4.2	125
130	4.3	4	3.8		6.9	5.4	4.3	6.9	5.4	4.3	6.9	5.4	4.2	6.7	5.3	4.2	130
135	4.2	3.9	3.8		6.6	5.3	4.2	6.7	5.3	4.2	6.7	5.3	4.2	6.5	5.2	4.1	135
140	4	3.8	3.8		6.4	5.1	4.2	6.5	5.2	4.2	6.5	5.1	4.2	6.3	5.1	4.1	140
145	3.9	3.8	3.8		6.2	5	4.2	6.3	5	4.2	6.3	5	4.1	6.2	5	4	145
150	3.8	3.8			6	4.9	4.1	6.1	4.9	4.1	6.1	4.9	4.1	6	4.8	4	150
155	3.7	3.8			5.8	4.8	4.1	5.9	4.8	4	6	4.8	4	5.9	4.7	4	155
160					5.7	4.6	4	5.8	4.7	4	5.8	4.7	4	5.7	4.6	3.9	160
165					5.5	4.6	3.9	5.6	4.6	3.9	5.7	4.6	3.9	5.6	4.6	3.9	165
170					5.3	4.5	3.9	5.5	4.5	3.9	5.5	4.5	3.9	5.5	4.5	3.8	170
175					5.2	4.4	3.9	5.3	4.4	3.8	5.3	4.4	3.8	5.3	4.4	3.8	175
180					5	4.3	3.8	5.2	4.3	3.8	5.2	4.3	3.8	5.2	4.3	3.7	180
185					4.9	4.2	3.8	5	4.2	3.8	5.1	4.3	3.7	5.1	4.2	3.7	185
190					4.8	4.1	3.8	4.9	4.2	3.8	5	4.2	3.7	4.9	4.2	3.7	190
195					4.7	4	3.8	4.8	4.1	3.7	4.9	4.1	3.7	4.8	4.1	3.6	195
200					4.5	4	3.8	4.7	4	3.7	4.7	4	3.7	4.7	4	3.6	200
205					4.4	3.9	3.8	4.6	4	3.7	4.6	4	3.6	4.6	4	3.6	205
210					4.3	3.9	3.8	4.4	3.9	3.7	4.5	3.9	3.6	4.5	3.9	3.6	210
215					4.2	3.8	3.8	4.3	3.9	3.7	4.4	3.9	3.6	4.4	3.8	3.6	215
220					4.1	3.8	3.8	4.2	3.8	3.7	4.3	3.8	3.6	4.3	3.8	3.6	220
225					4	3.8	3.8	4.2	3.8	3.7	4.3	3.8	3.6	4.2	3.8	3.6	225
230					4	3.8	3.8	4.1	3.7	3.7	4.2	3.7	3.6	4.2	3.7	3.6	230
235					3.9	3.8		4	3.7	3.7	4.1	3.7	3.6	4.1	3.7	3.6	235
240					3.8	3.8		3.9	3.7	3.7	4	3.7	3.6	4	3.6	3.6	240
245					3.8	3.8		3.9	3.7		3.9	3.7	3.6	4	3.6	3.6	245
250								3.8	3.7		3.9	3.6	3.6	3.9	3.6	3.6	250
255								3.7	3.7		3.8	3.6	3.6	3.8	3.6	3.6	255
260								3.7	3.7		3.7	3.6	3.6	3.8	3.6	3.6	260
265											3.7	3.6		3.7	3.6	3.6	265
270											3.7	3.6		3.7	3.6	3.6	270
275											2.5	3.6		3.6	3.6		275
280														3.6	3.6		280
285														3.3	3.6		285
290														2.4	3.4		290
295															2.5		295

t_240_002_56601_00_000

Lifting capacities Forces de levage

TNZK



↙ ↘	208 ft			224 ft			240 ft			253 ft			256 ft			↙ ↘
	115 ft			115 ft			115 ft			115 ft			115 ft			
	0°	20°	40°	0°	20°	40°	0°	20°	40°	0°	20°	40°	0°	20°	40°	
55	6.7															55
60	7.1			5.6												60
65	7.5			5.9			4.6									65
70	7.6			6.3			4.8									70
75	7.7			6.5			5.1			4			3.8			75
80	7.6			6.6			5.3			4			3.8			80
85	7.5			6.6			5.4			4.1			3.8			85
90	7.3			6.6			5.5			4.2			3.8			90
95	7.2			6.6			5.6			4.3			3.8			95
100	7.1	5.9		6.5			5.6			4.3			3.9			100
105	7	5.8		6.4	5.4		5.6			4.3			3.9			105
110	6.8	5.6		6.3	5.3		5.6			4.3			3.9			110
115	6.7	5.5		6.2	5.2		5.5	4.7		4.3			3.9			115
120	6.6	5.4		6.1	5.1		5.5	4.7		4.4	4.2		3.9	4.1		120
125	6.5	5.3	4.1	6	5		5.4	4.7		4.4	4.2		3.9	4.1		125
130	6.3	5.1	4	5.9	4.9		5.3	4.6		4.4	4.2		3.9	4.1		130
135	6.2	5	4	5.8	4.8	3.8	5.3	4.5		4.4	4.2		3.9	4.1		135
140	6.1	4.9	4	5.6	4.7	3.8	5.2	4.4	3.6	4.4	4.1		3.9	4		140
145	5.9	4.8	3.9	5.5	4.6	3.8	5.1	4.4	3.6	4.3	4.1		3.9	4		145
150	5.8	4.7	3.9	5.4	4.5	3.8	5	4.3	3.6	4.3	4	3.4	3.9	4	3.3	150
155	5.7	4.6	3.9	5.3	4.4	3.7	4.9	4.2	3.6	4.2	4	3.4	3.9	4	3.3	155
160	5.5	4.5	3.8	5.2	4.4	3.7	4.8	4.1	3.5	4.2	3.9	3.4	3.9	3.9	3.3	160
165	5.4	4.4	3.8	5.1	4.3	3.7	4.8	4.1	3.5	4.2	3.9	3.3	3.9	3.9	3.3	165
170	5.3	4.4	3.8	5	4.2	3.6	4.7	4	3.5	4.1	3.8	3.3	3.8	3.8	3.3	170
175	5.2	4.3	3.7	4.9	4.2	3.6	4.6	4	3.5	4.1	3.8	3.3	3.8	3.8	3.3	175
180	5	4.2	3.7	4.8	4.1	3.6	4.5	3.9	3.5	4	3.7	3.3	3.7	3.7	3.3	180
185	4.9	4.1	3.6	4.7	4	3.6	4.5	3.8	3.4	4	3.7	3.3	3.7	3.7	3.3	185
190	4.8	4.1	3.6	4.7	3.9	3.5	4.4	3.8	3.4	3.9	3.6	3.3	3.7	3.6	3.3	190
195	4.7	4	3.6	4.6	3.9	3.5	4.3	3.7	3.4	3.9	3.6	3.3	3.6	3.6	3.3	195
200	4.6	4	3.5	4.5	3.9	3.5	4.2	3.7	3.4	3.8	3.5	3.3	3.6	3.5	3.3	200
205	4.5	3.9	3.5	4.4	3.8	3.5	4.2	3.6	3.4	3.7	3.5	3.3	3.6	3.5	3.2	205
210	4.4	3.8	3.5	4.3	3.8	3.4	4.1	3.6	3.4	3.7	3.5	3.3	3.5	3.4	3.2	210
215	4.4	3.8	3.5	4.3	3.7	3.4	4	3.6	3.3	3.6	3.4	3.2	3.5	3.4	3.2	215
220	4.3	3.7	3.5	4.2	3.7	3.4	4	3.5	3.3	3.5	3.4	3.2	3.5	3.4	3.2	220
225	4.2	3.7	3.5	4.1	3.6	3.4	3.9	3.5	3.3	3.4	3.3	3.2	3.3	3.4	3.2	225
230	4.1	3.7	3.5	4	3.6	3.4	3.9	3.5	3.3	3.2	3.3	3.2	3.2	3.3	3.2	230
235	4.1	3.6	3.5	4	3.5	3.4	3.8	3.4	3.3	3.1	3.2	3.2	3.1	3.2	3.2	235
240	4	3.6	3.5	3.9	3.5	3.4	3.8	3.4	3.3	2.9	3.1	3.2	2.9	3.1	3.2	240
245	3.9	3.6	3.5	3.9	3.5	3.4	3.7	3.4	3.3	2.8	3	3.2	2.8	3	3.2	245
250	3.9	3.5	3.5	3.8	3.4	3.4	3.6	3.4	3.3	2.6	2.9	3.1	2.6	2.9	3.1	250
255	3.8	3.5	3.5	3.7	3.4	3.4	3.5	3.3	3.3	2.5	2.8	3.1	2.5	2.8	3	255
260	3.8	3.5	3.5	3.7	3.4	3.4	3.5	3.3	3.3	2.3	2.7	3	2.3	2.6	3	260
265	3.7	3.5	3.5	3.6	3.4	3.4	3.4	3.3	3.3	2.2	2.5	2.8		2.5	2.8	265
270	3.7	3.5	3.5	3.5	3.4	3.4	3.3	3.3	3.3		2.4	2.7		2.4	2.7	270
275	3.6	3.5	3.5	3.4	3.4	3.4	3.2	3.2	3.3		2.2	2.5		2.2	2.5	275
280	3.5	3.5	3.5	3.2	3.3	3.4	3	3.1	3.3			2.4			2.4	280
285	3.5	3.5		2.9	3.3	3.4		3.1	3.3			2.2				285
290	3.5	3.5		2.8	3.2	3.4		3	3.3							290
295	3.3	3.5		2.6	2.8	3.2		2.8	3.1							295
300	2.2	3.4		2.5	2.7				2.7							300
305		2.6			2.6											305
310					2.4											310

L_240_002_56601_00_000

Lifting heights Hauteurs de levage

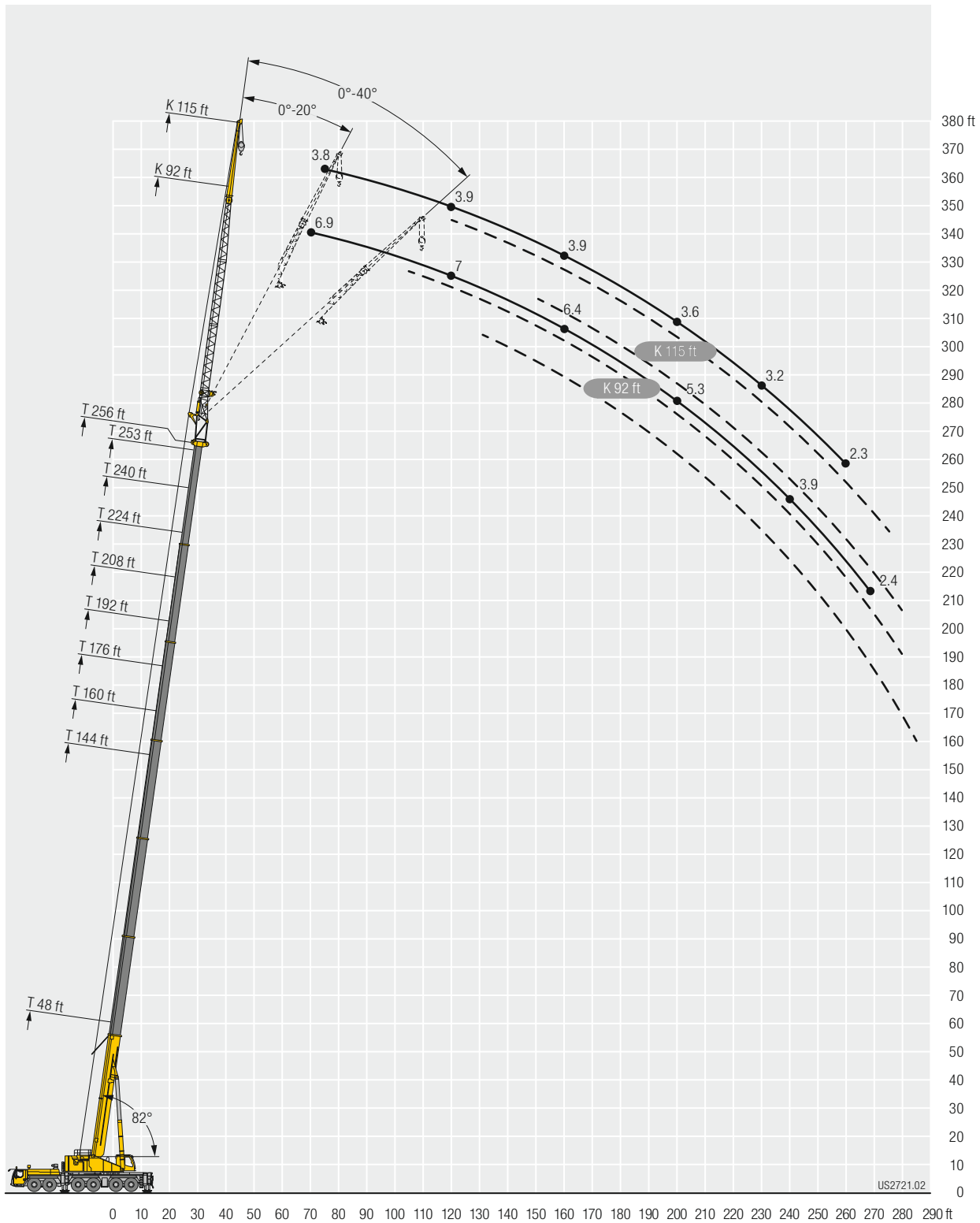

Lifting capacities Forces de levage

TF



↙ ↘	48 + 6.6 ft*			144 + 6.6 ft*			160 + 6.6 ft*			176 + 6.6 ft*			192 + 6.6 ft*			208 + 6.6 ft*			224 + 6.6 ft*			240 + 6.6 ft*			↙ ↘	
	46 ft			46 ft			46 ft			46 ft			46 ft			46 ft			46 ft			46 ft				
	0°	20°	40°	0°	20°	40°	0°	20°	40°	0°	20°	40°	0°	20°	40°	0°	20°	40°	0°	20°	40°	0°	20°	40°		
12	53.6																							12		
13	53.6																								13	
14	53.1																								14	
15	52.4																								15	
16	51.8																								16	
17	51																								17	
18	49.9																								18	
19	48.8																								19	
20	47.7																								20	
22	45.8																								22	
24	43.9																								24	
26	42.2																								26	
28	40.5	36.1																							28	
30	38.8	35.5		53.6																					30	
32	37.3	34.1		52.9																					32	
34	35.8	32.8		52.2																					34	
36	34.3	31.6		51.6			47.7																		36	
38	32.9	30.5		50.6			47.2																		38	
40	31.7	29.4	27	49.5			46.6		41.5																40	
45	28.8	27.1	26.7	46.8			44.8		40.8				35.1												45	
50	26.5	24.9	24.8	44.3	34.9		42.7		39.7				34.7			29.3									50	
55	24.4	23.2	23.2	42.1	33.2		40.8	32.9	38.4				34.3			29.1			23.4						55	
60	22.6	21.6	21.7	39.9	31.7	27	39.1	31.4	37.1	30.5			33.7			28.9			23.1				18.5		60	
65	21	20.2	20.4	38	30.4	26.8	37.4	30.2	35.7	29.4			33	27.9		28.5			22.9				18.3		65	
70	19.7	19	19.4	36	29	26	35.7	29	34.3	28.3	25.3		31.9	27		28	24.9		22.6				18		70	
75	18.4	17.9	18.4	34.1	27.9	25.2	34.2	27.9	33	27.3	24.6		30.9	26.2	23.6	27.2	24.3		22.3	20.9			17.7		75	
80	17.4	17	17.6	32.4	26.8	24.4	32.7	26.9	31.8	26.4	23.9		29.9	25.4	23	26.4	23.7		21.8	20.4			17.4	15.7	80	
85	16.5	16.3	17.1	30.9	25.7	23.6	31.2	25.9	30.6	25.5	23.2		28.9	24.6	22.4	25.5	23.1	21.2	21.2	19.9			17	15.3	85	
90	15.8	15.8		29.5	24.8	22.9	29.8	25	29.4	24.7	22.6		28	23.9	21.9	24.7	22.5	20.8	20.5	19.3	18.9		16.6	14.9	90	
95				28.1	23.9	22.3	28.7	24.2	28.2	24	22.1		27.1	23.2	21.4	23.9	22	20.4	19.9	18.7	18.4		16.1	14.5	13.9	95
100				27	23	21.7	27.5	23.4	27.2	23.2	21.5		26.3	22.6	20.9	23.1	21.5	20	19.2	18.2	17.8		15.7	14.1	13.5	100
105				25.9	22.3	21.1	26.4	22.6	26.3	22.5	21		25.4	22	20.5	22.3	20.9	19.6	18.6	17.7	17.3		15.2	13.7	13.1	105
110				24.8	21.6	20.5	25.4	21.9	25.4	21.9	20.6		24.6	21.4	20.1	21.5	20.3	19.2	18	17.2	16.8		14.8	13.3	12.8	110
115				23.8	20.9	20	24.5	21.3	24.5	21.3	20.1		23.9	20.9	19.7	20.8	19.7	18.9	17.4	16.6	16.4		14.3	12.9	12.5	115
120				22.9	20.3	19.6	23.6	20.7	23.7	20.7	19.7		23.2	20.4	19.3	20.1	19	18.5	16.9	16.1	15.9		13.9	12.6	12.2	120
125				22.1	19.7	19.2	22.8	20.1	23	20.2	19.3		22.5	19.9	19	19.4	18.4	18.1	16.3	15.6	15.5		13.5	12.3	11.9	125
130				21.2	19.1	18.8	22	19.6	22.3	19.7	19		21.8	19.4	18.6	18.7	17.8	17.7	15.7	15.1	15.1		13.1	12	11.6	130
135				20.5	18.6	18.4	21.3	19.1	21.6	19.2	18.6		21	19	18.3	18.1	17.2	17.2	15.2	14.6	14.6		12.8	11.6	11.3	135
140				19.9	18.1	18.1	20.6	18.6	20.9	18.8	18.3		20.1	18.6	18	17.4	16.7	16.7	14.6	14.1	14.2		12.4	11.3	11.1	140
145				19.2	17.7	17.8	20	18.2	20.3	18.4	18		19.2	18.2	17.7	16.8	16.2	16.2	14.1	13.6	13.7		12	11	10.8	145
150				18.6	17.3	17.5	19.4	17.8	19.8	18	17.7		18.3	17.9	17.5	16.2	15.7	15.7	13.6	13.2	13.3		11.6	10.8	10.6	150
155				18	16.9	17.3	18.9	17.4	19.2	17.6	17.5		17.5	17.3	17.3	15.6	15.2	15.2	13.2	12.8	12.9		11.2	10.5	10.3	155
160				17.5	16.6	17.1	18.4	17	18.6	17.2	17.2		16.7	16.8	17	14.9	14.7	14.7	12.7	12.4	12.5		10.8	10.2	10.1	160
165				17	16.3	17.1	17.8	16.7	17.9	16.9	17		15.9	16.3	16.7	14.3	14.2	14.3	12.3	12	12.1		10.5	10	9.9	165
170				16.6	16		17.4	16.4	16.7	16.6	16.9		15.2	15.7	16.1	13.7	13.8	13.9	11.9	11.5	11.7		10.1	9.7	9.7	170
175				16.2	15.9		16.9	16.1	15.5	16.2	16.7		14.4	15	15.4	13.1	13.4	13.5	11.4	11.2	11.3		9.8	9.5	9.5	175
180				15.8	15.8		16.1	15.9	14.6	15.3	15.9		13.8	14.3	14.7	12.5	12.9	13	11	10.8	11		9.4	9.2	9.3	180
185				10.9	13.1		15	15.6	14	14.2	14.7		13	13.6	14	11.8	12.4	12.6	10.6	10.5	10.6		9.1	8.9	9.1	185
190							14.1	14.5	13.5	13.7	13.9		12.1	12.9	13.3	11.3	11.8	12.1	10.2	10.1	10.3		8.7	8.7	8.8	190
195							12.5	13.5	12.7	13.1	13.3		11.2	12	12.5	10.7	11.3	11.5	9.7	9.8	10		8.4	8.4	8.5	195
200							8	9.9	11.9	12.4			10.6	11	11.5	10.2	10.7	11	9.3	9.5	9.7		8.2	8.1	8.3	200
205									11	11.5			10.2	10.3	10.5	9.5	10.2	10.4	8.9	9.1	9.3		7.9	7.8	8	205
210									9.6	10.6			9.8	9.9		8.8	9.6	9.8	8.5	8.8	9		7.6	7.6	7.7	210
215									6.1	7.6			9.4	9.5		8.2	8.9	9.1	8	8.5	8.6		7.4	7.4	7.5	215
220													8.8	9.2		7.9	8.1	8.2	7.6	8.1	8.2		7.1	7.2	7.3	220
225													7.6	8.5		7.6	7.7		7.1	7.6	7.8		6.8	7	7.1	225
230													5.8	6.2		7.2	7.4		6.5	7.2	7.3		6.5	6.7	6.9	230
235																7	7.1		6.3	6.6	6.7		6.2	6.5	6.7	235
240																6.2	6.9		6.1	6.2			5.8	6.2	6.4	240
245																5.2	5.4		5.8	6			5.3	6	6.1	245
250																			5.6	5.8			4.7	5.5		250
255																			5.1	5.6			4.1	4.9		255
260																				4.2			3.6	4.2		260
265																							3.6			265
270																							3			270

* adapter - pièce d'adaptateur

t_240_003_50101_00_000 / 52101_00_000 / 54101_00_000

Lifting capacities Forces de levage

TF



↙ ↘	48 + 6.6 ft*			144 + 6.6 ft*			160 + 6.6 ft*			176 + 6.6 ft*			192 + 6.6 ft*			208 + 6.6 ft*			224 + 6.6 ft*			240 + 6.6 ft*			↙ ↘
	69 ft			69 ft			69 ft			69 ft			69 ft			69 ft			69 ft			69 ft			
	0°	20°	40°	0°	20°	40°	0°	20°	40°	0°	20°	40°	0°	20°	40°	0°	20°	40°	0°	20°	40°	0°	20°	40°	
16	38.6																							16	
17	38.6																							17	
18	38.3																							18	
19	37.8																							19	
20	37.3																							20	
22	36.1																							22	
24	34.8																							24	
26	33.6																							26	
28	32.4																							28	
30	31.3																							30	
32	30.3																							32	
34	29.3																							34	
36	28.3				38.1																			36	
38	27.3				37.6																			38	
40	26.4	23.8			36.9			34.5																40	
45	24.2	22.8			35.2			33.4		30.3														45	
50	22.2	21.4			33.4			32.1		29.6			25.4											50	
55	20.5	19.9			31.8			30.7		28.8			25.1			21.3								55	
60	18.9	18.5	17		30.3	23.7		29.4		27.8			24.8			21.1			17.5					60	
65	17.6	17.3	16.1		28.9	23		28.2	22.6	26.8			24.4			20.9			17.2			13.6		65	
70	16.3	16.1	15.3		27.5	22.2		27.1	22	25.9	21.4		24			20.7			17			13.4		70	
75	15.3	15.2	14.6		26.3	21.4		26	21.2	25	20.7		23.5	19.5		20.4			16.7			13.1		75	
80	14.3	14.3	13.9		25	20.6	16.9	24.9	20.5	24.1	20		22.9	19		20.1			16.5			12.9		80	
85	13.4	13.5	13.3		23.8	19.8	16.4	23.9	19.8	23.2	19.3		22.2	18.5		19.7	17.1		16.3			12.8		85	
90	12.7	12.7	12.6		22.7	19	15.9	22.9	19	22.4	18.7	15.7	21.5	17.9		19.3	16.8		16.1	15.1		12.6		90	
95	12	12.1	12.1		21.7	18.3	15.5	21.9	18.4	21.6	18.1	15.4	20.8	17.4	15	18.9	16.3		15.9	14.8		12.3	11.3	95	
100	11.4	11.5	11.6		20.7	17.7	15.2	20.9	17.8	20.8	17.5	15	20.2	16.9	14.7	18.4	15.9	14.2	15.5	14.6		12	11	100	
105	10.8	11	11.2		19.7	17	14.8	20.1	17.2	20	17	14.8	19.5	16.4	14.4	18	15.5	13.9	15.1	14.2		11.7	10.7	105	
110	10.4	10.6	10.4		18.9	16.4	14.5	19.3	16.6	19.2	16.5	14.5	18.9	16	14.2	17.5	15.1	13.7	14.7	13.9	12.9	11.3	10.3	110	
115	10.1	10.5			18.2	15.9	14.2	18.6	16.1	18.6	16	14.2	18.3	15.5	13.9	17	14.8	13.4	14.4	13.6	12.6	11	10	9.6	115
120					17.5	15.4	13.9	17.9	15.6	18	15.5	13.9	17.7	15.1	13.6	16.6	14.4	13.1	13.9	13.3	12.4	10.7	9.8	9.3	120
125					16.7	14.9	13.5	17.2	15.1	17.4	15.1	13.6	17.2	14.7	13.4	16.1	14.1	12.8	13.5	12.9	12.2	10.3	9.5	9	125
130					16	14.4	13.2	16.6	14.7	16.8	14.7	13.3	16.7	14.3	13.1	15.6	13.8	12.6	13.1	12.6	12	10	9.2	8.8	130
135					15.5	14	12.9	16	14.3	16.2	14.3	13	16.2	14	12.8	15.1	13.4	12.4	12.6	12.2	11.8	9.8	8.9	8.6	135
140					14.9	13.6	12.6	15.4	13.8	15.8	13.9	12.8	15.7	13.7	12.6	14.7	13.1	12.2	12.2	11.9	11.6	9.5	8.7	8.4	140
145					14.4	13.2	12.4	14.9	13.4	15.3	13.5	12.5	15.3	13.3	12.4	14.2	12.9	12	11.8	11.5	11.3	9.2	8.5	8.2	145
150					13.9	12.8	12.1	14.4	13.1	14.8	13.2	12.3	14.9	13	12.1	13.7	12.6	11.8	11.4	11.2	11	8.9	8.2	7.9	150
155					13.4	12.5	11.9	14	12.8	14.4	12.9	12.1	14.5	12.7	11.9	13.2	12.4	11.7	11	10.8	10.8	8.6	8	7.8	155
160					13	12.2	11.7	13.5	12.5	14	12.6	11.9	14.1	12.5	11.7	12.8	12.1	11.5	10.6	10.5	10.5	8.4	7.8	7.6	160
165					12.6	11.9	11.5	13.1	12.2	13.6	12.3	11.7	13.7	12.2	11.6	12.4	11.8	11.3	10.3	10.2	10.2	8.2	7.6	7.4	165
170					12.2	11.6	11.4	12.7	11.9	13.2	12	11.5	13.3	11.9	11.4	12	11.6	11.2	9.9	9.8	9.9	7.9	7.4	7.3	170
175					11.8	11.3	11.3	12.4	11.6	12.8	11.8	11.4	12.9	11.7	11.3	11.6	11.3	11.1	9.6	9.5	9.7	7.7	7.2	7.1	175
180					11.5	11.1	11.2	12	11.4	12.5	11.5	11.3	12.6	11.5	11.1	11.2	11	10.9	9.2	9.2	9.4	7.5	7.1	7	180
185					11.2	10.9	11.2	11.7	11.2	12.2	11.3	11.1	12.2	11.3	11	10.8	10.7	10.7	8.9	8.9	9.1	7.3	6.9	6.8	185
190					10.9	10.7	11.2	11.4	11	11.8	11.1	11	11.8	11.1	10.9	10.4	10.4	10.5	8.6	8.6	8.8	7.1	6.8	6.7	190
195					10.6	10.6		11.1	10.8	11	10.9	11	11.4	10.9	10.8	10	10.1	10.2	8.3	8.3	8.5	6.9	6.7	6.6	195
200					10.3	10.5		10.8	10.6	11	10.7	10.9	10.8	10.7	10.7	9.5	9.7	9.9	8	8	8.2	6.7	6.5	6.5	200
205					10.1	10.5		10.6	10.5	10.9	10.6	10.9	10.4	10.5	10.6	9.1	9.4	9.7	7.8	7.8	7.9	6.6	6.4	6.4	205
210					10.4	10.4		10.5	10.4	10.9	10.5	10.4	9.6	10.3	10.4	8.7	9	9.4	7.5	7.5	7.7	6.4	6.2	6.3	210
215					10.2	10.3		10.1	10.1	10.5	10.1	10.5	8.9	9.8	10.1	8.3	8.7	9.1	7.3	7.3	7.4	6.2	6.1	6.2	215
220					7.6	10.1		9.6	9.8	8.1	9.1	9.5	7.9	8.3	8.7	7	7.1	7.2	6	6	6.1	6	6	6.1	220
225					3.6			8.9	9.5	7.7	8.3	8.6	7.5	7.9	8.2	6.7	6.9	7	5.8	5.9	6	5.8	5.9	6	225
230								8.3	8.7	7.4	7.6	7.7	6.9	7.5	7.7	6.4	6.7	6.8	5.7	5.7	5.9	5.7	5.7	5.9	230
235								5.9	7.8	7.1	7.3		6.4	7.1	7.3	6.1	6.5	6.6	5.5	5.6	5.7	5.5	5.6	5.7	235
240								2.2	3.7	6.9	7		6	6.5	6.7	5.8	6.3	6.4	5.2	5.4	5.5	5.2	5.4	5.5	240
245										6.6	6.8		5.8	6	6.1	5.4	6	6.1	5	5.2	5.4	5	5.2	5.4	245
250										4.4	6.2		5.5	5.7		4.9	5.6	5.8	4.7	5.1	5.2	4.7	5.1	5.2	250
255										4.1	4.3		5.3	5.5		4.7	5.1	5.4	4.5	4.9	5	4.5	4.9	5	255
260													5.1	5.3		4.5	4.6		4.2	4.6	4.8	4.2	4.6	4.8	260
265													3.9	4.9		4.3	4.5		3.7	4.3	4.5	3.7	4.3	4.5	265
270																3.3			4.2	4.3		3.1	3.9	4	270
275																			4	4.1		2.6	3.3		275
280																			2.2	3.8		2.7	2.7		280

* adapter - pièce d'adaptateur

t_240_003_50301_00_000 / 52301_00_000 / 54301_00_000

Lifting capacities Forces de levage

TF



Lifting hook icon	48 + 6.6 ft*			144 + 6.6 ft*			160 + 6.6 ft*			176 + 6.6 ft*			192 + 6.6 ft*			208 + 6.6 ft*			224 + 6.6 ft*			240 + 6.6 ft*			Lifting hook icon	
	80 ft			80 ft			80 ft			80 ft			80 ft			80 ft			80 ft							
	0°	20°	40°	0°	20°	40°	0°	20°	40°	0°	20°	40°	0°	20°	40°	0°	20°	40°	0°	20°	40°	0°	20°	40°		
18	31.8																							18		
19	31.8																							19		
20	31.5																							20		
22	30.7																							22		
24	29.8																							24		
26	29																							26		
28	28.2																							28		
30	27.4																							30		
32	26.6																							32		
34	25.9																							34		
36	25.1																							36		
38	24.4				31.3																			38		
40	23.6				30.9			27																40		
45	21.9				29.6			28.4			26.1													45		
50	20.3	18.2			28.4			27.3			25.6			22.2										50		
55	18.8	17.2			27.2			26.4			25.1			22										55		
60	17.5	16.3			26.1			25.8			24.5			21.7			18.5							60		
65	16.2	15.5			25			24.9			23.8			21.3			18.3			15				65		
70	15.1	14.7	13.1		23.9	18.2		24	17.9		23			20.9			18.1			14.7			11.4	70		
75	14	13.9	12.6		22.9	17.6		23.1	17.5		22.3			20.5			17.8			14.4			11.2	75		
80	13.1	13	12.1		21.9	17.1		22.2	17		21.6	16.6		19.9			17.5			14.2			11	80		
85	12.3	12.3	11.7		21	16.6		21.4	16.5		20.9	16.2		19.4	15.6		17.2			14			10.9	85		
90	11.5	11.6	11.2		20.1	16.1	13.1	20.6	16.1		20.2	15.8		18.9	15.3		16.8	14.2		13.9			10.7	90		
95	10.9	11	10.8		19.2	15.7	12.8	19.8	15.7	12.8	19.5	15.4		18.3	14.9		16.5	13.9		13.7	10.4		10.6	95		
100	10.3	10.4	10.3		18.4	15.2	12.5	18.9	15.3	12.5	18.8	15.1	12.5	17.8	14.6		16.1	13.6		13.5	12.4		10.5	100		
105	9.7	9.9	9.9		17.6	14.8	12.3	18.2	14.8	12.3	18.1	14.7	12.2	17.2	14.2	12.1	15.7	13.3		13.3	12.2		10.3	9.4	105	
110	9.2	9.4	9.5		16.8	14.3	12	17.5	14.4	12.1	17.4	14.3	12	16.7	13.8	11.8	15.4	13	11.5	13.1	11.9		10.1	9.1	110	
115	8.8	9	9.2		16.1	13.9	11.8	16.8	14	11.8	16.8	13.9	11.8	16.2	13.5	11.6	15	12.8	11.2	12.9	11.7		9.8	8.8	115	
120	8.4	8.6	9.1		15.4	13.4	11.6	16.1	13.5	11.6	16.2	13.5	11.6	15.7	13.1	11.4	14.6	12.5	11	12.7	11.5	10.5	9.5	8.6	120	
125	8.2	8.4			14.8	12.9	11.4	15.5	13.1	11.4	15.7	13.1	11.4	15.1	12.8	11.2	14.2	12.2	10.9	12.3	11.3	10.4	9.2	8.3	7.9	125
130					14.2	12.5	11.2	15	12.7	11.2	15.1	12.7	11.1	14.7	12.4	11	13.8	11.9	10.7	12	11	10.2	8.9	8.1	7.7	130
135					13.6	12.2	10.9	14.4	12.3	11	14.6	12.3	10.9	14.2	12.1	10.8	13.5	11.6	10.5	11.6	10.8	10	8.6	7.8	7.5	135
140					13.1	11.8	10.7	13.9	12	10.8	14.1	12	10.8	13.8	11.8	10.6	13.1	11.3	10.3	11.2	10.6	9.8	8.4	7.6	7.3	140
145					12.6	11.4	10.5	13.4	11.7	10.6	13.7	11.7	10.6	13.4	11.5	10.4	12.7	11.1	10.1	10.8	10.3	9.7	8.1	7.4	7.1	145
150					12.2	11.1	10.3	12.9	11.3	10.4	13.2	11.4	10.4	13	11.2	10.2	12.4	10.8	10	10.5	10	9.5	7.8	7.2	7	150
155					11.7	10.8	10.1	12.5	11	10.2	12.8	11.1	10.2	12.6	10.9	10.1	12.1	10.6	9.8	10.1	9.8	9.4	7.6	7	6.8	155
160					11.3	10.5	9.9	12.1	10.7	10	12.4	10.8	10	12.3	10.7	9.9	11.7	10.4	9.6	9.8	9.5	9.2	7.4	6.9	6.7	160
165					10.9	10.2	9.7	11.7	10.4	9.8	12	10.5	9.8	11.9	10.4	9.7	11.4	10.1	9.5	9.4	9.2	9.1	7.2	6.7	6.5	165
170					10.6	9.9	9.5	11.4	10.1	9.6	11.6	10.3	9.6	11.6	10.2	9.6	11.1	9.9	9.4	9.1	9	8.9	7	6.5	6.4	170
175					10.2	9.7	9.4	11	9.9	9.5	11.3	10	9.5	11.3	10	9.4	10.7	9.7	9.2	8.7	8.7	8.7	6.8	6.4	6.3	175
180					9.9	9.4	9.2	10.7	9.7	9.3	11	9.8	9.4	11	9.7	9.3	10.3	9.6	9.1	8.4	8.4	8.5	6.6	6.2	6.1	180
185					9.6	9.2	9.1	10.4	9.5	9.2	10.7	9.6	9.2	10.7	9.5	9.2	10	9.4	9	8.2	8.2	8.3	6.5	6.1	6	185
190					9.3	9	9.1	10.1	9.3	9.1	10.4	9.4	9.1	10.4	9.4	9.1	9.6	9.2	8.9	7.9	7.9	8	6.3	6	5.9	190
195					9	8.8	9.1	9.8	9.1	9	10.1	9.2	9	10.2	9.2	9	9.3	9	8.8	7.6	7.7	7.8	6.2	5.8	5.7	195
200					8.8	8.7	9.1	9.5	8.9	9	9.9	9	8.9	9.9	9	8.9	8.9	8.8	8.7	7.4	7.4	7.6	6	5.7	5.6	200
205					8.6	8.5		9.3	8.7	9	9.6	8.9	8.9	9.6	8.9	8.8	8.6	8.5	8.6	7.1	7.1	7.3	5.9	5.6	5.5	205
210					8.4	8.5		9	8.6	9	9.4	8.7	8.8	9.2	8.7	8.7	8.2	8.3	8.5	6.8	6.9	7.1	5.7	5.5	5.4	210
215					8.2	8.4		8.8	8.5	9	9.1	8.6	8.8	8.9	8.6	8.7	7.9	8.1	8.3	6.6	6.7	6.9	5.6	5.3	5.3	215
220					5.8	7.9		8.6	8.4		8.8	8.5	8.8	8.4	8.4	8.7	7.5	7.8	8.1	6.4	6.5	6.7	5.5	5.2	5.2	220
225								8.4	8.4		8.6	8.4	8.8	7.7	8.2	8.6	7.2	7.5	7.8	6.2	6.3	6.5	5.3	5.1	5.2	225
230								7.4	8.4		8.3	8.2		7.1	7.9	8.3	6.9	7.2	7.6	6	6.1	6.3	5.1	5	5.1	230
235								4.1	5.9		7.9	8.2		6.7	7.4	7.7	6.5	7	7.2	5.8	5.9	6.2	5	4.9	5	235
240											7.3	7.8		6.5	6.8	7	6	6.6	6.9	5.5	5.8	6	4.8	4.8	4.9	240
245											5.5	7.2		6.2	6.4		5.4	6.3	6.5	5.2	5.6	5.8	4.6	4.7	4.8	245
250											2.4	4.4		6	6.2		5.1	5.8	6	4.9	5.4	5.6	4.4	4.6	4.7	250
255														5.7	5.9		4.9	5.2	5.4	4.4	5.1	5.3	4.2	4.4	4.6	255
260														3.9	5.6		4.7	4.9		4	4.8	4.9	3.9	4.3	4.4	260
265														3.4	3.5		4.6	4.7		3.8	4.3	4.5	3.7	4.1	4.3	265
270																	4.3	4.5		3.7	3.8	4	3.2	3.8	4	270
275																	3.1	4.3		3.5	3.6		2.5	3.5	3.7	275
280																				3.3	3.5			3.1	3.3	280
285																				3.1	3.3					285
290																					3.1					290

* adapter - pièce d'adaptateur

t_240_003_50401_00_000 / 52401_00_000 / 54401_00_000

Lifting capacities Forces de levage

TF



↙ ↘	48 + 6.6 ft*			144 + 6.6 ft*			160 + 6.6 ft*			176 + 6.6 ft*			192 + 6.6 ft*			208 + 6.6 ft*			224 + 6.6 ft*			240 + 6.6 ft*			↙ ↘					
	92 ft			92 ft			92 ft			92 ft			92 ft			92 ft			92 ft			92 ft								
	0°	20°	40°	0°	20°	40°	0°	20°	40°	0°	20°	40°	0°	20°	40°	0°	20°	40°	0°	20°	40°	0°	20°	40°						
19	26.8																							19						
20	27																							20						
22	26.8																							22						
24	26.2																							24						
26	25.6																							26						
28	24.9																							28						
30	24.3																							30						
32	23.6																							32						
34	23																							34						
36	22.4																							36						
38	21.8																							38						
40	21.2				26.6																			40						
45	19.7				25.7			24.7																45						
50	18.5				24.8			23.8			22.4													50						
55	17.3	14.8			23.8			22.9			21.7			19.3										55						
60	16.2	14			22.8			22.1			21			19.1			16.3							60						
65	15.3	13.3			21.9			21.4			20.4			18.7			16.1			13.1				65						
70	14.4	12.7			21			20.6			19.7			18.2			15.9			12.9			9.8	70						
75	13.5	12.1			20.1	14.7		19.9			19.1			17.7			15.6			12.7			9.7	75						
80	12.7	11.5	9.9		19.3	14.3		19.1	14.1		18.4			17.2			15.3			12.5			9.5	80						
85	11.8	11	9.5		18.6	13.8		18.4	13.7		17.8	13.5		16.7			15.1			12.4			9.4	85						
90	11.1	10.5	9.2		17.9	13.4		17.8	13.4		17.3	13.1		16.3	12.7		14.7			12.2			9.3	90						
95	10.5	10	8.9		17.1	13		17.1	13		16.7	12.8		15.8	12.4		14.4	11.7		12			9.2	95						
100	9.8	9.5	8.6		16.5	12.7	9.9		16.5	12.6	9.9			16.2	12.4		15.4	12.1		11.9			9.1	100						
105	9.3	9.1	8.4		15.9	12.3	9.7		15.9	12.3	9.7			15.7	12.1		14.9	11.8		11.8	10.5		9	105						
110	8.8	8.6	8.2		15.3	12	9.5		15.4	12	9.5			15.2	11.9	9.5		14.5	11.6		11.6	10.2		8.9	8.1	110				
115	8.3	8.2	8		14.8	11.7	9.3		14.9	11.7	9.3			14.7	11.6	9.3		14.2	11.3	9.2	13.1	10.8		11.4	10.1	8.7	7.9	115		
120	7.9	7.8	7.9		14.3	11.4	9.1		14.4	11.4	9.2			14.3	11.3	9.1		13.8	11.1	9	12.8	10.6	8.9	11.2	9.9	8.4	7.7	120		
125	7.5	7.5	7.6		13.7	11.1	9		13.9	11.1	9			13.8	11.1	9		13.4	10.8	8.9	12.5	10.5	8.7	11.1	9.7	8.2	7.5	125		
130	7.2	7.2	7.5		13.2	10.8	8.8		13.4	10.9	8.9			13.4	10.8	8.9		13	10.6	8.8	12.2	10.2	8.6	10.8	9.5	8.4	7.9	7.3	130	
135	7	7.1			12.7	10.5	8.7		13	10.6	8.7			12.9	10.6	8.7		12.6	10.4	8.6	11.9	10	8.5	10.5	9.3	8.3	7.7	7.1	6.8	135
140					12.2	10.2	8.5		12.5	10.4	8.6			12.5	10.4	8.6		12.2	10.2	8.5	11.6	9.8	8.4	10.3	9.2	8.2	7.5	6.9	6.6	140
145					11.7	10	8.4		12.1	10.1	8.5			12.1	10.1	8.5		11.9	10	8.4	11.3	9.6	8.3	10	9	8.1	7.3	6.7	6.5	145
150					11.3	9.7	8.3		11.7	9.9	8.4			11.7	9.9	8.4		11.5	9.8	8.3	11	9.4	8.2	9.7	8.8	8	7.1	6.5	6.3	150
155					10.9	9.4	8.2		11.2	9.6	8.3			11.4	9.7	8.3		11.1	9.6	8.2	10.7	9.2	8.2	9.4	8.7	8	6.9	6.4	6.1	155
160					10.5	9.2	8.2		10.9	9.3	8.2			11	9.4	8.2		10.8	9.3	8.1	10.4	9	8.1	9.1	8.5	7.9	6.7	6.2	6	160
165					10.1	8.9	8.1		10.5	9.1	8.1			10.7	9.2	8.1		10.5	9.1	8.1	10.1	8.8	8	8.8	8.3	7.8	6.5	6.1	5.9	165
170					9.7	8.7	8		10.2	8.9	8			10.3	9	8		10.3	8.9	8	9.9	8.6	7.9	8.5	8.1	7.7	6.4	5.9	5.7	170
175					9.4	8.4	8		9.8	8.6	8			10	8.7	8		10	8.7	8	9.6	8.4	7.8	8.2	7.9	7.6	6.2	5.8	5.6	175
180					9.1	8.2	7.9		9.5	8.4	7.9			9.7	8.5	7.9		9.7	8.5	7.9	9.4	8.2	7.8	7.9	7.7	7.5	6	5.6	5.5	180
185					8.8	8	7.8		9.2	8.2	7.8			9.4	8.3	7.9		9.4	8.3	7.8	9.1	8.1	7.7	7.6	7.5	7.4	5.9	5.5	5.4	185
190					8.5	7.8	7.7		8.9	8	7.7			9.2	8.1	7.7		9.1	8.1	7.7	8.9	7.9	7.6	7.3	7.4	7.3	5.7	5.4	5.2	190
195					8.3	7.6	7.6		8.7	7.8	7.6			8.9	8	7.6		8.9	7.9	7.6	8.6	7.8	7.5	7.1	7.2	7.2	5.6	5.3	5.1	195
200					8	7.5	7.5		8.4	7.7	7.6			8.6	7.8	7.6		8.7	7.8	7.5	8.4	7.6	7.4	6.9	7	7	5.4	5.1	5	200
205					7.8	7.3	7.5		8.2	7.5	7.5			8.4	7.6	7.5		8.5	7.6	7.4	8.1	7.5	7.3	6.7	6.8	6.9	5.3	5	4.9	205
210					7.5	7.2	7.5		7.9	7.4	7.5			8.2	7.5	7.4		8.3	7.5	7.3	7.8	7.4	7.3	6.5	6.6	6.7	5.2	4.9	4.9	210
215					7.4	7.1			7.7	7.3	7.4			8	7.3	7.4		8	7.4	7.3	7.6	7.3	7.2	6.3	6.4	6.5	5	4.8	4.8	215
220					7.2	7.1			7.5	7.2	7.4			7.8	7.2	7.4		7.8	7.3	7.3	7.3	7.2	7.2	6.1	6.2	6.3	4.9	4.7	4.7	220
225					7	7.1			7.3	7.1	7.4			7.6	7.1	7.3		7.6	7.2	7.2	7	7	7.1	5.9	6	6.2	4.8	4.6	4.6	225
230					6.3	7.1			7.2	7				7.4	7	7.3		7.3	7.1	7.2	6.7	6.9	7	5.7	5.8	6	4.7	4.5	4.5	230
235									7	7				7.2	7	7.3		6.9	7	7.2	6.4	6.7	7	5.5	5.6	5.8	4.5	4.4	4.4	235
240									6.8	7				7.1	6.9	7.3		6.4	6.9	7.2	6.1	6.5	6.8	5.3	5.4	5.6	4.4	4.3	4.4	240
245									4.3	6.5				6.9	6.9			6	6.7	7.1	5.7	6.3	6.5	5.1	5.2	5.5	4.2	4.2	4.3	245
250														6.7	6.9			5.8	6.3	6.5	5.2	6	6.3	4.8	5.1	5.3	4	4.1	4.2	250
255														5.3	6.7			5.6	5.8		4.7	5.7	5.9	4.5	4.9	5.1	3.9	4	4.2	255
260															4.9			5.4	5.6		4.5	5.2	5.5	4.2	4.7	4.9	3.7	3.9	4.1	260
265																		5.1	5.3		4.3	4.6	4.9	3.7	4.5	4.7	3.5	3.7	4	265
270																		3.7	5.1		4.1	4.3		3.3	4.2	4.4	3.2	3.6	3.9	270
275																		2.8	3.4		3.9	4.1		3.2	3.7	3.9		3.5	3.7	275
280																					3.7	3.9		3	3.2	3.4		3.3	3.4	280
285																					2.5	3.7		2.9	3			2.7	3.1	285
290																						2.4		2.7	2.9				2.1	290
295																							2.1	2.7						295
300																								2.2						300

* adapter - pièce d'adaptateur

t_240_003_50501_00_000 / 52501_00_000 / 54501_00_000

Lifting capacities Forces de levage

TF



↙ ↘	48 + 6.6 ft*			144 + 6.6 ft*			160 + 6.6 ft*			176 + 6.6 ft*			192 + 6.6 ft*			208 + 6.6 ft*			224 + 6.6 ft*			240 + 6.6 ft*			↙ ↘				
	103 ft			103 ft			103 ft			103 ft			103 ft			103 ft			103 ft			103 ft							
	0°	20°	40°	0°	20°	40°	0°	20°	40°	0°	20°	40°	0°	20°	40°	0°	20°	40°	0°	20°	40°	0°	20°	40°					
22	23.1																							22					
24	22.9																								24				
26	22.4																								26				
28	21.8																								28				
30	21.2																								30				
32	20.7																								32				
34	20.1																								34				
36	19.6																								36				
38	19.1																								38				
40	18.6																								40				
45	17.4				22.3			21.1																	45				
50	16.3				21.3			20.5			19.2														50				
55	15.3				20.5			19.7			18.6														55				
60	14.3	12.2			19.7			19			18			16.7											60				
65	13.3	11.5			18.9			18.4			17.5			16.3			14.1								65				
70	12.6	10.9			18.2			17.7			16.9			15.8			13.9			11.2					70				
75	11.9	10.3			17.4			17.1			16.4			15.3			13.6			11			8.3		75				
80	11.2	9.8			16.7	12.1		16.5			15.9			14.9			13.4			10.8			8.1		80				
85	10.6	9.3			16	11.6		15.9	11.6		15.4			14.4			13.1			10.6			8		85				
90	10	8.8	7.6		15.4	11.3		15.3	11.2		14.9	11		14			12.8			10.5			7.9		90				
95	9.5	8.4	7.3		14.8	10.9		14.7	10.9		14.3	10.7		13.6	10.3		12.4			10.4			7.7		95				
100	8.9	8	7.1		14.2	10.6		14.2	10.5		13.9	10.4		13.2	10.1		12.1			10.3			7.6		100				
105	8.3	7.7	6.8		13.6	10.3		13.7	10.2		13.4	10.1		12.8	9.8		11.8	9.4		10.1			7.5		105				
110	7.9	7.3	6.6		13.1	10	7.6		13.2	10	7.6	13	9.8		12.4	9.6		11.5	9.2	10	8.5		7.5		110				
115	7.5	7.1	6.5		12.6	9.7	7.4		12.7	9.7	7.4	12.6	9.6	7.4		12.1	9.3		11.2	8.9		9.8	8.4	7.4		115			
120	7.1	6.9	6.4		12.1	9.4	7.3		12.3	9.4	7.3	12.1	9.3	7.3		11.7	9.1	7.2	11	8.7		9.7	8.2	7.3	6.8		120		
125	6.8	6.7	6.3		11.7	9.1	7.2		11.9	9.2	7.2	11.8	9.1	7.1		11.4	8.9	7.1	10.7	8.5		9.5	8	7.1	6.7		125		
130	6.5	6.5	6.2		11.3	8.8	7		11.5	8.9	7	11.4	8.9	7		11.1	8.7	7	10.5	8.4	6.9	9.3	7.9	7	6.5		130		
135	6.2	6.2	6.2		10.9	8.5	6.9		11.1	8.7	6.9	11.1	8.7	6.9		10.8	8.5	6.9	10.2	8.2	6.8	9.1	7.7	6.9	6.3		135		
140	6	6	6.2		10.6	8.3	6.8		10.7	8.4	6.9	10.7	8.4	6.8		10.5	8.3	6.8	10	8	6.7	8.9	7.6	6.5	6.7	6.1		140	
145	5.8	5.9			10.2	8.1	6.7		10.4	8.2	6.7	10.4	8.2	6.7		10.2	8.1	6.7	9.7	7.9	6.6	8.7	7.5	6.4	6.5	6	5.7		145
150	5.7				9.8	7.9	6.6		10.1	8	6.7	10.1	8	6.7		9.9	8	6.6	9.5	7.8	6.5	8.5	7.4	6.4	6.3	5.8	5.6		150
155					9.5	7.7	6.5		9.8	7.8	6.6	9.8	7.8	6.6		9.7	7.8	6.5	9.2	7.6	6.5	8.4	7.3	6.3	6.2	5.6	5.4		155
160					9.1	7.5	6.5		9.5	7.6	6.5	9.5	7.6	6.5		9.4	7.6	6.5	9	7.5	6.4	8.2	7.1	6.3	6	5.5	5.3		160
165					8.8	7.3	6.4		9.2	7.5	6.4	9.3	7.5	6.4		9.2	7.5	6.4	8.8	7.3	6.3	7.9	7	6.2	5.8	5.3	5.2		165
170					8.5	7.2	6.3		8.9	7.3	6.4	9	7.3	6.4		8.9	7.3	6.3	8.6	7.2	6.3	7.7	6.9	6.2	5.6	5.2	5		170
175					8.1	7	6.3		8.6	7.2	6.3	8.7	7.2	6.3		8.7	7.2	6.3	8.3	7.1	6.2	7.5	6.8	6.1	5.5	5.1	4.9		175
180					7.9	6.9	6.3		8.3	7	6.3	8.4	7.1	6.3		8.4	7.1	6.2	8.1	7	6.2	7.2	6.7	6.1	5.3	4.9	4.8		180
185					7.6	6.8	6.2		8	6.9	6.2	8.2	7	6.2		8.2	7	6.2	7.9	6.9	6.1	7	6.6	6.1	5.2	4.8	4.7		185
190					7.4	6.7	6.2		7.7	6.8	6.2	7.9	6.9	6.2		7.9	6.9	6.2	7.7	6.8	6.1	6.7	6.5	6	5.1	4.7	4.6		190
195					7.1	6.6	6.2		7.5	6.7	6.2	7.7	6.8	6.2		7.7	6.8	6.1	7.5	6.7	6.1	6.5	6.4	6	4.9	4.6	4.5		195
200					6.9	6.5	6.2		7.3	6.6	6.2	7.5	6.7	6.2		7.5	6.7	6.1	7.4	6.6	6	6.3	6.3	6	4.8	4.5	4.4		200
205					6.7	6.4	6.2		7.1	6.5	6.2	7.3	6.5	6.1		7.3	6.6	6.1	7.2	6.5	6	6.1	6.2	6	4.6	4.3	4.3		205
210					6.6	6.2	6.2		6.9	6.4	6.2	7.1	6.4	6.1		7.1	6.4	6.1	7	6.4	6	5.9	6	6	4.5	4.2	4.2		210
215					6.4	6.1	6.2		6.7	6.2	6.2	6.9	6.3	6.1		6.9	6.3	6.1	6.8	6.2	6	5.7	5.8	5.9	4.4	4.1	4.1		215
220					6.2	6	6.2		6.6	6.1	6.2	6.8	6.2	6.1		6.8	6.2	6.1	6.6	6.2	6	5.6	5.7	5.8	4.2	4	4		220
225					6.1	5.9	6.2		6.4	6.1	6.2	6.6	6.1	6.1		6.6	6.1	6.1	6.4	6.1	6	5.4	5.5	5.7	4.1	3.9	3.9		225
230					6	5.9			6.3	6	6.2	6.4	6	6.1		6.5	6	6	6.2	6	6	5.2	5.3	5.5	4	3.8	3.8		230
235					5.8	5.8			6.1	5.9	6.2	6.3	5.9	6.1		6.4	6	6	6	5.9	5.9	5	5.1	5.4	3.9	3.7	3.7		235
240					5.7	5.8			6	5.8		6.2	5.9	6.1		6.2	5.9	6	5.8	5.8	5.9	4.8	5	5.2	3.7	3.6	3.7		240
245									5.9	5.8		6.1	5.8	6.1		6	5.8	6	5.5	5.6	5.9	4.6	4.8	5	3.6	3.5	3.6		245
250									5.8	5.8		5.9	5.7	6.1		5.5	5.7	6	5.2	5.5	5.8	4.4	4.6	4.9	3.4	3.5	3.5		250
255									4.2	5.8		5.8	5.7			5.2	5.7	6	4.7	5.4	5.7	4.2	4.4	4.7	3.3	3.4	3.5		255
260									5.7	5.7		5.7	5.7			5	5.6	5.8	4.2	5.2	5.5	3.9	4.3	4.5	3.1	3.3	3.4		260
265									4.8	5.7		4.8	5	5.2		4.8	5	5.2	3.8	4.8	5.2	3.6	4.1	4.4	3	3.2	3.3		265
270									2.3	5		2.3	5			4.6	4.8		3.7	4.4	4.7	3.3	3.9	4.1	2.8	3.1	3.3		270
275																4.3	4.6		3.5	3.8	4.1	2.8	3.7	3.9		2.9	3.2		275
280																3.1	4.4		3.3	3.5		2.5	3.4	3.5		2.8	3		280
285																	3.4		3.1	3.3		2.3	2.9	3.1		2.5	2.9		285
290																			2.8	3.1			2.4	2.7					290
295																				2.9			2.3						295
300																				2.1			2.1						300

* adapter - pièce d'adaptateur

t_240_003_50601_00_000 / 52601_00_000 / 54601_00_000

Lifting capacities Forces de levage

TF



↙ ↘	48 + 6.6 ft*			144 + 6.6 ft*			160 + 6.6 ft*			176 + 6.6 ft*			192 + 6.6 ft*			208 + 6.6 ft*			224 + 6.6 ft*			240 + 6.6 ft*			↙ ↘
	115 ft			115 ft			115 ft			115 ft			115 ft			115 ft			115 ft			115 ft			
	0°	20°	40°	0°	20°	40°	0°	20°	40°	0°	20°	40°	0°	20°	40°	0°	20°	40°	0°	20°	40°	0°	20°	40°	
24	19.6																							24	
26	19.5																							26	
28	19.2																							28	
30	18.7																							30	
32	18.2																							32	
34	17.7																							34	
36	17.2																							36	
38	16.8																							38	
40	16.4																							40	
45	15.4				19.3																			45	
50	14.5				18.6			17.8																50	
55	13.5				17.8			17.1			16.2													55	
60	12.7				17.1			16.5			15.6			14.4										60	
65	11.9	10			16.4			15.9			15.1			14			12.4							65	
70	11.1	9.5			15.8			15.3			14.6			13.6			12.2							70	
75	10.5	9			15.2			14.8			14.2			13.3			11.9		9.6					75	
80	9.8	8.5			14.6			14.3			13.7			12.9			11.6		9.4			6.9		80	
85	9.3	8			13.9			13.7			13.3			12.5			11.3		9.3			6.9		85	
90	8.8	7.6			13.4	9.6		13.2	9.5		12.8			12.1			11		9.1			6.8		90	
95	8.3	7.2	6.2		12.8	9.2		12.8	9.2		12.4	9		11.7			10.7		9			6.7		95	
100	7.8	6.8	6		12.3	8.9		12.3	8.9		12	8.7		11.4			10.4		8.8			6.7		100	
105	7.4	6.5	5.8		11.8	8.6		11.8	8.6		11.5	8.5		11	8.2		10.2		8.7			6.6		105	
110	7	6.3	5.6		11.3	8.3		11.4	8.3		11.2	8.2		10.7	8		9.9	7.6	8.6			6.5		110	
115	6.6	6	5.4		10.9	8	6.2	11	8		10.8	8		10.3	7.7		9.6	7.4	8.5			6.4		115	
120	6.3	5.8	5.2		10.5	7.7	6	10.5	7.8	6	10.4	7.7		10	7.5		9.4	7.2	8.3	6.8		6.4		120	
125	6	5.6	5.1		10.1	7.5	5.9	10.2	7.5	5.9	10.1	7.5	5.8	9.7	7.4		9.1	7.1	8.1	6.7		6.2		125	
130	5.7	5.4	5		9.7	7.3	5.8	9.8	7.3	5.8	9.7	7.3	5.8	9.4	7.2	5.6	8.9	6.9	7.9	6.6		6.1	5.7	130	
135	5.5	5.3	4.9		9.3	7.1	5.7	9.5	7.1	5.7	9.4	7.1	5.7	9.2	7	5.6	8.6	6.8	7.8	6.5		5.9	5.6	135	
140	5.2	5.1	4.9		9	6.9	5.6	9.1	6.9	5.6	9.1	7	5.6	8.9	6.9	5.5	8.4	6.7	7.6	6.4		5.8	5.4	140	
145	5	5	4.8		8.7	6.7	5.5	8.8	6.8	5.5	8.8	6.8	5.5	8.6	6.7	5.4	8.2	6.6	7.5	6.3		5.6	5.3	145	
150	4.8	4.9	4.8		8.4	6.5	5.4	8.5	6.6	5.4	8.5	6.6	5.4	8.4	6.6	5.3	8	6.4	7.3	6.2	5.1	5.5	5.1	150	
155	4.7	4.9	4.8		8.1	6.3	5.3	8.3	6.5	5.3	8.3	6.5	5.3	8.1	6.5	5.3	7.8	6.3	7.2	6.1	5.1	5.3	5	4.8	155
160	4.6	4.8			7.8	6.2	5.2	8	6.3	5.2	8	6.3	5.2	7.9	6.3	5.2	7.6	6.2	7.1	5.9	5	5.2	4.8	4.7	160
165					7.5	6.1	5.1	7.8	6.2	5.2	7.8	6.2	5.2	7.7	6.2	5.1	7.4	6.1	6.9	5.9	5	5	4.7	4.5	165
170					7.3	5.9	5.1	7.5	6	5.1	7.6	6.1	5.1	7.4	6.1	5.1	7.2	5.9	6.8	5.8	4.9	4.8	4.6	4.4	170
175					7	5.8	5	7.3	5.9	5	7.4	5.9	5	7.3	5.9	5	7.1	5.8	6.6	5.7	4.9	4.7	4.4	4.3	175
180					6.8	5.7	5	7	5.8	5	7.2	5.8	5	7.1	5.8	5	6.9	5.7	6.4	5.6	4.8	4.5	4.3	4.2	180
185					6.5	5.6	4.9	6.8	5.7	4.9	7	5.7	4.9	7	5.7	4.9	6.8	5.6	6.3	5.5	4.8	4.4	4.2	4.1	185
190					6.3	5.4	4.9	6.6	5.6	4.9	6.8	5.6	4.9	6.8	5.6	4.9	6.6	5.5	6.1	5.4	4.8	4.3	4	4	190
195					6.2	5.3	4.9	6.4	5.5	4.9	6.6	5.5	4.9	6.6	5.5	4.8	6.5	5.5	5.9	5.3	4.7	4.1	3.9	3.9	195
200					6	5.3	4.9	6.2	5.4	4.8	6.4	5.4	4.8	6.5	5.4	4.8	6.4	5.4	5.7	5.3	4.7	4	3.8	3.8	200
205					5.8	5.2	4.8	6	5.3	4.8	6.3	5.3	4.8	6.3	5.3	4.8	6.2	5.3	5.5	5.2	4.7	3.9	3.7	3.7	205
210					5.6	5.1	4.8	5.9	5.2	4.8	6.1	5.3	4.8	6.2	5.3	4.8	6.1	5.2	5.4	5.1	4.7	3.8	3.6	3.6	210
215					5.4	5	4.8	5.7	5.1	4.8	5.9	5.2	4.8	6	5.2	4.7	6	5.2	5.2	5	4.7	3.6	3.5	3.5	215
220					5.3	5	4.8	5.6	5.1	4.8	5.8	5.1	4.8	5.9	5.1	4.7	5.8	5.1	5	4.9	4.6	3.5	3.4	3.4	220
225					5.2	4.9	4.8	5.4	5	4.8	5.6	5.1	4.8	5.8	5.1	4.7	5.7	5	4.8	4.8	4.6	3.4	3.3	3.3	225
230					5	4.9	4.8	5.3	5	4.8	5.5	5	4.8	5.6	5	4.7	5.5	5	4.6	4.7	4.6	3.3	3.2	3.3	230
235					4.9	4.9	4.8	5.2	4.9	4.8	5.4	4.9	4.8	5.5	5	4.7	5.4	4.9	4.4	4.6	4.6	3.2	3.1	3.2	235
240					4.8	4.9		5	4.9	4.8	5.2	4.9	4.8	5.4	4.9	4.7	5.2	4.9	4.2	4.5	4.6	3.1	3	3.1	240
245					4.7	4.8		4.9	4.8	4.8	5.1	4.9	4.8	5.3	4.9	4.7	5.1	4.9	4.1	4.3	4.6	3	2.9	3	245
250					4.6	4.8		4.8	4.8	4.8	5	4.8	4.8	5.2	4.8	4.7	4.9	4.8	3.9	4.1	4.4	2.9	2.8	3	250
255					4.7	4.8		4.7	4.8		4.9	4.8	4.8	5	4.8	4.7	4.6	4.7	3.7	4	4.3	2.8	2.7	2.9	255
260					4.6	4.8		4.8	4.8		4.8	4.7	4.8	4.7	4.7	4.7	4.2	4.6	3.5	3.8	4.1	2.6	2.6	2.8	260
265					4	4.8		4.7	4.7		4.7	4.7		4.5	4.7	4.7	3.8	4.5	3.3	3.6	4	2.6	2.8		265
270							2.6	4.6	4.7		4.6	4.7		4.2	4.7	4.7	3.4	4.3	3.1	3.5	3.8	2.5	2.7		270
275								4.1	4.7		4.1	4.7		4	4.4	4.5	3	4	2.8	3.3	3.6	2.4	2.6		275
280									4.7			4.7		3.8	4.1		2.9	3.6	2.4	3.1	3.4	2.3	2.5		280
285												4.7		3.5	3.9		2.7	3.1	2.7	3.1	3.5	2.4	2.4		285
290														2.5	3.7		2.5	2.8	2.7	2.8	2.9	2.3	2.3		290
295														3.1			2.4	2.6		2.5					295
300																	2.4								300
305																	2.2								305

* adapter - pièce d'adaptateur

t_240_003_50701_00_000 / 52701_00_000 / 54701_00_000

Lifting capacities Forces de levage

TF



↙ ↘	48 + 6.6 ft*			144 + 6.6 ft*			160 + 6.6 ft*			176 + 6.6 ft*			192 + 6.6 ft*			208 + 6.6 ft*			224 + 6.6 ft*			240 + 6.6 ft*			↙ ↘	
	126 ft			126 ft			126 ft			126 ft			126 ft			126 ft			126 ft			126 ft				
	0°	20°	40°	0°	20°	40°	0°	20°	40°	0°	20°	40°	0°	20°	40°	0°	20°	40°	0°	20°	40°	0°	20°	40°		
28	16.7																							28		
30	16.4																							30		
32	16																							32		
34	15.6																							34		
36	15.2																							36		
38	14.8																							38		
40	14.5																							40		
45	13.6																							45		
50	12.8				16.2			15.3																50		
55	12				15.5			14.9																55		
60	11.3				14.9			14.3			13.5													60		
65	10.6				14.3			13.8			13.1			12.1										65		
70	9.9	8.1			13.7			13.3			12.6			11.7			10.6							70		
75	9.2	7.8			13.2			12.8			12.2			11.4			10.4			8.1				75		
80	8.7	7.3			12.6			12.4			11.8			11.1			10.1			8			5.5	80		
85	8.1	7			12.1			11.9			11.5			10.8			9.8			7.9			5.5	85		
90	7.6	6.6			11.6			11.5			11.1			10.4			9.5			7.7			5.5	90		
95	7.3	6.3			11.2	7.8		11			10.7			10.1			9.2			7.6			5.5	95		
100	6.9	6			10.7	7.5		10.6	7.5		10.3			9.8			8.9			7.5			5.5	100		
105	6.5	5.7	4.9		10.3	7.3		10.2	7.2		10	7.1		9.5			8.7			7.4			5.6	105		
110	6.2	5.4	4.7		9.8	7		9.8	7		9.6	6.9		9.2	6.8		8.4			7.3			5.6	110		
115	5.9	5.2	4.5		9.4	6.8		9.5	6.8		9.3	6.7		8.8	6.6		8.2			7.2			5.5	115		
120	5.6	5	4.4		9	6.6		9.1	6.6		8.9	6.5		8.5	6.4		7.9	6.1		7.1			5.4	120		
125	5.3	4.8	4.2		8.6	6.3	4.9	8.7	6.4		8.6	6.4		8.3	6.3		7.7	6		6.9			5.3	125		
130	5	4.6	4.1		8.3	6.2	4.8	8.4	6.2	4.8	8.3	6.2		8	6.1		7.5	5.9		6.8	5.5		5.2	130		
135	4.8	4.4	4		7.9	6	4.6	8.1	6	4.6	8	6	4.6	7.8	5.9		7.3	5.7		6.7	5.4		5.1	4.7	135	
140	4.6	4.2	3.9		7.6	5.8	4.6	7.8	5.9	4.6	7.7	5.8	4.5	7.5	5.8	4.4	7.1	5.6		6.5	5.3		4.9	4.6	140	
145	4.4	4.1	3.8		7.4	5.6	4.5	7.5	5.7	4.5	7.5	5.7	4.4	7.3	5.6	4.4	6.9	5.5		6.4	5.2		4.8	4.5	145	
150	4.2	4	3.7		7.1	5.5	4.4	7.2	5.5	4.4	7.2	5.6	4.4	7	5.5	4.3	6.8	5.4	4.2	6.2	5.1		4.6	4.3	150	
155	4	3.9	3.7		6.9	5.3	4.3	7	5.4	4.3	7	5.4	4.3	6.9	5.4	4.2	6.6	5.2	4.2	6.1	5		4.5	4.2	155	
160	3.8	3.8	3.7		6.7	5.2	4.2	6.8	5.3	4.2	6.8	5.3	4.2	6.7	5.2	4.2	6.4	5.1	4.1	6	4.9	4	4.3	4	160	
165	3.7	3.8	3.7		6.4	5	4.1	6.6	5.1	4.1	6.6	5.2	4.1	6.5	5.1	4.1	6.3	5	4	5.9	4.8	3.9	4.2	3.9	165	
170	3.6	3.8			6.2	4.9	4.1	6.4	5	4.1	6.4	5	4.1	6.4	5	4	6.1	4.9	4	5.7	4.7	3.9	4	3.8	3.8	170
175					6	4.8	4	6.2	4.9	4	6.3	4.9	4	6.2	4.9	4	6	4.8	3.9	5.6	4.6	3.8	3.9	3.7	3.7	175
180					5.8	4.7	3.9	6	4.8	4	6.1	4.8	4	6	4.8	3.9	5.9	4.7	3.9	5.5	4.6	3.8	3.8	3.5	3.6	180
185					5.6	4.6	3.9	5.9	4.7	3.9	6	4.7	3.9	5.9	4.7	3.9	5.7	4.6	3.8	5.4	4.5	3.7	3.6	3.4	3.4	185
190					5.5	4.5	3.8	5.7	4.6	3.9	5.8	4.6	3.9	5.8	4.6	3.8	5.6	4.5	3.8	5.2	4.4	3.7	3.5	3.3	3.3	190
195					5.3	4.4	3.8	5.5	4.5	3.8	5.6	4.5	3.8	5.6	4.5	3.8	5.5	4.4	3.8	5.1	4.3	3.7	3.4	3.1	3.2	195
200					5.1	4.3	3.8	5.3	4.4	3.8	5.5	4.4	3.8	5.5	4.4	3.8	5.4	4.4	3.7	4.9	4.2	3.7	3.2	3	3.1	200
205					4.9	4.2	3.7	5.2	4.3	3.7	5.3	4.3	3.7	5.4	4.3	3.7	5.2	4.3	3.7	4.8	4.2	3.6	3.1	2.9	3	205
210					4.8	4.1	3.7	5	4.2	3.7	5.2	4.2	3.7	5.2	4.3	3.7	5.1	4.2	3.7	4.7	4.1	3.6	3	2.8	2.9	210
215					4.6	4	3.7	4.9	4.1	3.7	5	4.2	3.7	5.1	4.2	3.7	5	4.1	3.6	4.5	4	3.6	2.8	2.6	2.8	215
220					4.5	4	3.7	4.7	4.1	3.7	4.9	4.1	3.7	5	4.1	3.6	4.9	4.1	3.6	4.3	4	3.6	2.7	2.5	2.7	220
225					4.3	3.9	3.7	4.6	4	3.7	4.7	4	3.7	4.8	4	3.6	4.8	4	3.6	4.2	3.9	3.6	2.6	2.4	2.6	225
230					4.2	3.9	3.7	4.5	3.9	3.7	4.6	4	3.6	4.7	4	3.6	4.7	4	3.6	4	3.9	3.5	2.5	2.3	2.4	230
235					4.1	3.8	3.7	4.3	3.9	3.7	4.5	3.9	3.6	4.6	3.9	3.6	4.6	3.9	3.6	3.8	3.8	3.5	2.4	2.2	2.3	235
240					4	3.8	3.7	4.2	3.8	3.7	4.4	3.9	3.6	4.5	3.9	3.6	4.5	3.9	3.6	3.6	3.7	3.5	2.2		2.3	240
245					3.9	3.8	3.7	4.1	3.8	3.7	4.3	3.8	3.6	4.4	3.8	3.6	4.3	3.8	3.6	3.5	3.6	3.5	2.1		2.2	245
250					3.8	3.8		4	3.8	3.7	4.2	3.8	3.6	4.3	3.8	3.6	4.2	3.8	3.6	3.3	3.6	3.5				250
255					3.7	3.8		3.9	3.8	3.7	4.1	3.7	3.6	4.2	3.8	3.6	4.1	3.7	3.6	3.1	3.4	3.5				255
260					3.6	3.8		3.8	3.8	3.7	4	3.7	3.6	4.1	3.7	3.6	3.9	3.7	3.6	3	3.3	3.5				260
265					2.8	3.8		3.7	3.8		3.9	3.7	3.6	4	3.7	3.6	3.7	3.6	3.6	2.8	3.1	3.4				265
270								3.6	3.8		3.8	3.7	3.6	3.7	3.7	3.6	3.3	3.6	3.6	2.6	3	3.3				270
275								3.5	3.8		3.7	3.7		3.6	3.7	3.6	2.9	3.5	3.6	2.5	2.8	3.1				275
280									3.5		3.6	3.7		3.4	3.7	3.6	2.5	3.5	3.6		2.7	3				280
285											3.3	3.7		3.2	3.5	3.6	2.2	3.3	3.5		2.5	2.8				285
290												3.7		3	3.3						2.3	2.6				290
295														2.7	3.1							2.4				295
300															2.9											300
305															2.4											305

* adapter - pièce d'adaptateur

t_240_003_50801_00_000 / 52801_00_000 / 54801_00_000

Lifting capacities Forces de levage

TF



↙ ↘	48 + 6.6 ft*			144 + 6.6 ft*			160 + 6.6 ft*			176 + 6.6 ft*			192 + 6.6 ft*			208 + 6.6 ft*			224 + 6.6 ft*			240 + 6.6 ft*			↙ ↘				
	138 ft			138 ft			138 ft			138 ft			138 ft			138 ft			138 ft			138 ft							
	0°	20°	40°	0°	20°	40°	0°	20°	40°	0°	20°	40°	0°	20°	40°	0°	20°	40°	0°	20°	40°	0°	20°	40°					
30	14.2																							30					
32	14																							32					
34	13.7																							34					
36	13.4																							36					
38	13.1																							38					
40	12.7																							40					
45	12																							45					
50	11.3				14																			50					
55	10.6				13.5			12.9																55					
60	10				13			12.5			11.7													60					
65	9.4				12.4			12			11.4			10.5										65					
70	8.8				11.9			11.6			11			10.2										70					
75	8.2				11.5			11.1			10.6			9.9				8.9						75					
80	7.6	6.5			11			10.7			10.2			9.6				8.7			6.9			80					
85	7.2	6.2			10.6			10.4			9.9			9.3				8.5			6.9		4.2	85					
90	6.8	5.8			10.1			10			9.6			9				8.2			6.8		4.2	90					
95	6.5	5.5			9.7			9.6			9.3			8.7				8			6.7		4.2	95					
100	6.1	5.2			9.3	6.5		9.2			8.9			8.5				7.7			6.6		4.3	100					
105	5.8	5			8.9	6.3		8.9	6.3		8.6			8.2				7.5			6.6		4.3	105					
110	5.5	4.7			8.5	6.1		8.5	6.1		8.3	6		7.9				7.2			6.5		4.3	110					
115	5.2	4.5	3.9		8.2	5.8		8.2	5.9		8	5.8		7.6				7			6.3		4.3	115					
120	4.9	4.3	3.7		7.8	5.6		7.8	5.7		7.7	5.6		7.3	5.5			6.8			6.2		4.3	120					
125	4.7	4.1	3.6		7.5	5.5		7.5	5.5		7.5	5.5		7.1	5.4			6.7	5.2		6		4.2	125					
130	4.5	3.9	3.4		7.2	5.3		7.2	5.3		7.2	5.3		6.9	5.2			6.5	5		5.9		4.2	130					
135	4.2	3.8	3.3		6.9	5.1	3.6		7	5.1		6.9	5.1		6.7	5		6.3	4.9		5.8	4.6		4.1	135				
140	4	3.6	3.2		6.7	5	3.6		6.7	5	3.6		6.7	5		6.5	4.9		6.1	4.8		5.6	4.5		4	140			
145	3.9	3.5	3.1		6.5	4.8	3.5		6.5	4.9	3.5		6.5	4.8	3.4		6.3	4.8		6	4.6		5.5	4.4		3.9	3.7	145	
150	3.7	3.3	3		6.2	4.6	3.4		6.3	4.7	3.4		6.3	4.7	3.4		6.1	4.6	3.3	5.8	4.5		5.4	4.3		3.8	3.6	150	
155	3.5	3.2	2.9		6	4.5	3.3		6.1	4.6	3.3		6.1	4.6	3.3		6	4.5	3.2	5.7	4.4		5.3	4.2		3.7	3.4	155	
160	3.3	3.1	2.9		5.8	4.4	3.3		5.9	4.4	3.3		5.9	4.5	3.2		5.8	4.4	3.2	5.5	4.3	3.1	5.2	4.1		3.5	3.3	160	
165	3.2	3	2.9		5.6	4.2	3.2		5.7	4.3	3.2		5.8	4.3	3.2		5.6	4.3	3.2	5.4	4.2	3.1	5	4		3.4	3.1	165	
170	3	3	2.9		5.4	4.1	3.1		5.5	4.2	3.2		5.6	4.2	3.1		5.5	4.2	3.1	5.2	4.1	3	4.9	3.9	2.9	3.3	3	170	
175	2.9	2.9	2.9		5.2	4	3.1		5.4	4.1	3.1		5.4	4.1	3.1		5.3	4.1	3.1	5.1	4	3	4.8	3.8	2.8	3.1	2.9	175	
180	2.8	2.9			5	3.9	3		5.2	4	3.1		5.3	4	3		5.2	4	3	5	3.9	2.9	4.7	3.8	2.8	3	2.7	2.7	180
185	2.8				4.9	3.8	3		5	3.9	3		5.1	3.9	3		5	3.9	3	4.9	3.8	2.9	4.6	3.7	2.8	2.8	2.6	2.6	185
190					4.7	3.7	2.9		4.9	3.8	3		5	3.8	3		4.9	3.8	2.9	4.8	3.7	2.9	4.5	3.6	2.8	2.7	2.5	2.6	190
195					4.5	3.6	2.9		4.7	3.7	2.9		4.8	3.7	2.9		4.8	3.7	2.9	4.7	3.6	2.9	4.4	3.5	2.8	2.5	2.3	2.5	195
200					4.4	3.5	2.9		4.6	3.6	2.9		4.7	3.6	2.9		4.7	3.6	2.9	4.5	3.6	2.8	4.3	3.5	2.7	2.4	2.2	2.4	200
205					4.2	3.4	2.9		4.4	3.5	2.9		4.5	3.5	2.9		4.6	3.5	2.9	4.4	3.5	2.8	4.2	3.4	2.7	2.3		2.3	205
210					4.1	3.4	2.9		4.3	3.4	2.9		4.4	3.5	2.9		4.4	3.5	2.8	4.3	3.4	2.8	4.1	3.3	2.7	2.2		2.1	210
215					4	3.3	2.9		4.2	3.4	2.8		4.3	3.4	2.9		4.3	3.4	2.8	4.2	3.4	2.8	4	3.3	2.7				215
220					3.8	3.2	2.9		4	3.3	2.8		4.2	3.3	2.9		4.2	3.3	2.8	4.1	3.3	2.8	3.9	3.2	2.7				220
225					3.7	3.2	2.9		3.9	3.2	2.8		4	3.3	2.8		4.1	3.3	2.8	4.1	3.2	2.8	3.7	3.2	2.7				225
230					3.6	3.1	2.9		3.8	3.2	2.8		3.9	3.2	2.8		4	3.2	2.8	4	3.2	2.8	3.5	3.1	2.7				230
235					3.5	3	2.9		3.7	3.1	2.8		3.8	3.1	2.8		3.9	3.1	2.8	3.9	3.1	2.8	3.4	3	2.7				235
240					3.4	3	2.9		3.6	3.1	2.8		3.7	3.1	2.8		3.8	3.1	2.8	3.8	3.1	2.8	3.2	3	2.7				240
245					3.3	3	2.9		3.5	3	2.8		3.6	3	2.8		3.7	3.1	2.8	3.7	3	2.7	3.1	3	2.7				245
250					3.2	2.9	2.9		3.4	3	2.8		3.5	3	2.8		3.6	3	2.8	3.6	3	2.7	2.9	2.9	2.7				250
255					3.1	2.9	2.9		3.3	2.9	2.8		3.4	3	2.8		3.5	3	2.8	3.5	3	2.7	2.8	2.9	2.7				255
260					3	2.9			3.2	2.9	2.8		3.3	2.9	2.8		3.4	2.9	2.8	3.4	2.9	2.7	2.6	2.8	2.7				260
265					2.9	2.9			3.1	2.9	2.8		3.2	2.9	2.8		3.3	2.9	2.8	3.3	2.9	2.7	2.5	2.8	2.7				265
270					2.8	2.9			3	2.9	2.8		3.2	2.9	2.8		3.3	2.9	2.8	3.2	2.8	2.7		2.6	2.7				270
275					2.8	2.9			2.9	2.9			3.1	2.9	2.8		3.2	2.8	2.8	3	2.8	2.7		2.5	2.7				275
280									2.9	2.9			3	2.8	2.8		3.1	2.8	2.8	2.7	2.8	2.7		2.3	2.6				280
285									2.8	2.9			2.9	2.8	2.8		2.9	2.8	2.8	2.3	2.8	2.7		2.2	2.5				285
290										2.9			2.9	2.8	2.8		2.8	2.8	2.8		2.8	2.7			2.4				290
295											2.9		2.8	2.8		2.6	2.8	2.8	2.8		2.7	2.7		2.2					295
300												2.8		2.8		2.4	2.7				2.3	2.6							300
305													2.2		2.1	2.5						2.2							305
310																2.3													310

* adapter - pièce d'adaptateur

t_240_003_50901_00_000 / 52901_00_000 / 54901_00_000

Lifting heights Hauteurs de levage

TF

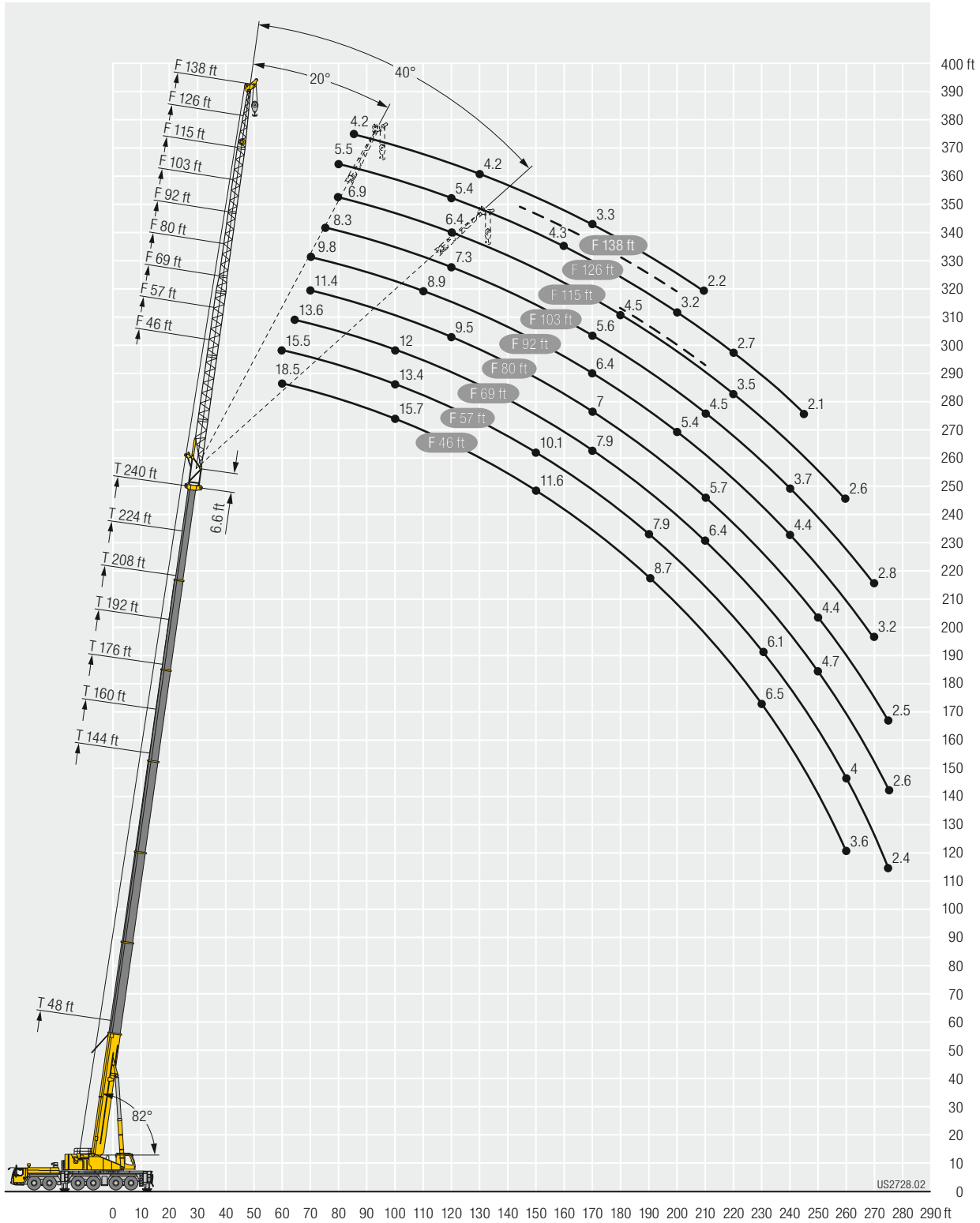

Lifting capacities Forces de levage

TN



	48 + 11.5 ft*			64 + 11.5 ft*			80 + 11.5 ft*			96 + 11.5 ft*			112 + 11.5 ft*			
	57 ft**			57 ft**			57 ft**			57 ft**			57 ft**			
	82°	75°	68°	82°	75°	68°	82°	75°	68°	82°	75°	68°	82°	75°	68°	
26	110.7															26
28	110.8															28
30	110.7			103.2												30
32	110.3			103.9			93.9									32
34	109.3			104.4			94.2			82.8						34
36	108			104.8			94.4			82.8						36
38	107			104.9			94.4			82.7			70.8			38
40	106.1	105.1		104.6			94.4			82.6			70.7			40
45	103.5	98.5		102.5	100.6		94.4			82.6			70.7			45
50	95.6	93.2		100.2	97.6		94.4	91.4		82.6			70.7			50
55	83.9	89.5	86.2	90.4	94.6		93	91.1		82.6	79.8		70.7			55
60	65.5	86.5	81.6	79	91.7	89.2	85.4	89.9		82.6	79.9		70.7	68.2		60
65		78.8	78.3		88	84.7	72.9	88.8		80.5	80.4		70.7	68.2		65
70			77.2		78.3	81.6		86.3	81.7		80.8		70.7	68.2		70
75			72.9			79		78	75.9		78.5	73.1		68.2		75
80						73.7			70.7		73.2	68.2		68.2		80
85									66			63.7		65.9	60.1	85
90												59.7			56.4	90
95															53	95
100															49.9	100

* adapter - pièce d'adaptateur

** Hookblock with deadweight of 2,200 lbs necessary - Moufle a crochet de poids minimal de 2,200 lbs nécessaire

t_240_004_50101_00_000



	128 + 11.5 ft*			144 + 11.5 ft*			160 + 11.5 ft*			176 + 11.5 ft*		192 + 11.5 ft*		208 + 11.5 ft*	224 + 11.5 ft*	240 + 11.5 ft*	
	57 ft**			57 ft**			57 ft**			57 ft**		57 ft**		57 ft**			
	82°	75°	68°	82°	75°	68°	82°	75°	68°	82°	75°	82°	75°	82°			
40	60.7																40
45	60.6			49.7													45
50	60.5			49.6			39.3										50
55	60.5			49.6			39.2			32.2		25					55
60	60.5			49.6			39			32.1		24.9		18.7			60
65	60.5	58.4		49.6			38.9			32		24.9		18.7	12.7	7.7	65
70	60.5	58.5		49.6			38.9			31.9		24.8		18.6	12.6	7.6	70
75		58.8		49.6	48		38.9			31.9		24.8		18.5	12.4	7.4	75
80		59.1			48.1			37.8				24.8		18.4	12.3	7.3	80
85		59.1			48			37.6			30.3				12.2	7.2	85
90		59	54.3		47			37.4			30.2						90
95			51.1					37.3			30						95
100			48.2			40.6					29.9				23.1		100
105			45.5			39.2			33					22.9			105
110						37.9			31.8								110
115									30.9								115

* adapter - pièce d'adaptateur

** Hookblock with deadweight of 2,200 lbs necessary - Moufle a crochet de poids minimal de 2,200 lbs nécessaire

t_240_004_50101_00_000

Lifting capacities Forces de levage

TN



↙ ↘	48 + 11.5 ft*			64 + 11.5 ft*			80 + 11.5 ft*			96 + 11.5 ft*			112 + 11.5 ft*			↙ ↘	
	69 ft			69 ft			69 ft			69 ft			69 ft				
	82°	75°	68°	82°	75°	68°	82°	75°	68°	82°	75°	68°	82°	75°	68°		
30	97.7															30	
32	97.6			91.4												32	
34	97.1			91.5												34	
36	96.2			91.6			83.4									36	
38	95.1			91.4			83.2			73.4						38	
40	94			91.1			83.1			73.4						40	
45	91.5	90.3		89.5			82.8			73.1			63.4			45	
50	89.4	86.9		87.9	86.8		82.6			73			63.3			50	
55	87.9	83		86.8	84.4		82.3	80.5		73			63.3			55	
60	83.7	79.6	77.8	85.6	82.5		81.9	79.2		73	70.9		63.3			60	
65	73.7	77.3	73.7	81.2	80.8	79.3	81.9	77.7		73	70.8		63.3	61.3		65	
70	57.8	75.9	70.6	69.3	79.6	76.3	77	76.6		73	70.5		63.3	61.2		70	
75		70.6	68.3	51.8	79.2	73.6	64.4	76	74.2	73	69.9		63.3	61.2		75	
80			67.7		71.4	71.4		74.8	70.3		69.7	67.6		63.3	61.2	80	
85			65.8			68.6		69.9	65.7		68.3	63.5			61.2	85	
90						64.4			61.6		64.2	59.6			60.8	55.9	90
95									57.9			56			58	52.6	95
100												52.9				49.7	100
105																46.9	105
110																44.4	110

* adapter - pièce d'adaptateur

t_240_004_50201_00_000



↙ ↘	128 + 11.5 ft*			144 + 11.5 ft*			160 + 11.5 ft*			176 + 11.5 ft*			192 + 11.5 ft*			208 + 11.5 ft*		224 + 11.5 ft*		240 + 11.5 ft*		↙ ↘
	69 ft			69 ft			69 ft			69 ft			69 ft			69 ft		69 ft		69 ft		
	82°	75°	68°	82°	75°	68°	82°	75°	68°	82°	75°	68°	82°	75°	68°	82°	75°	82°	75°	82°	75°	
45	54.5																					45
50	54.5			44.9			34.6															50
55	54.5			44.9			34.5			28.3												55
60	54.5			44.9			34.2			28.2			21.5									60
65	54.5			44.9			34			28			21.4		15.9							65
70	54.5	52.7		44.9			33.9			27.9			21.3		15.7	10.3			5.9			70
75	54.5	52.8		44.9	43.3		33.8			27.8			21.3		15.6	10.1			5.8			75
80	54.5	52.9		44.9	43.3		33.8			27.8			21.3		15.4	10			5.7			80
85		53.1		44.9	43		33.8	32.9		27.7			21.3		15.3	9.9			5.6			85
90		53.3			42.9			32.7		27.7	26.8		21.3		15.3	9.8			5.5			90
95		53.6	50.5		42.7			32.6			26.7				15.3	9.8			5.5			95
100		52.9	47.7		42			32.5			26.6			20.2								100
105			45.1		41.2	37.5		32.5			26.5					14.1						105
110			42.7			36.3					26.5					13.9						110
115			40.5			35.2				29.4				19.9		13.8		8.7				115
120						34.2				28.5						13.8		8.6		4.5		120
125										27.7							8.5		4.4			125
130																			4.4			130
135																						135
140																						140

* adapter - pièce d'adaptateur

t_240_004_50201_00_000

Lifting capacities Forces de levage

TN



↙ ↘	48 + 11.5 ft*			64 + 11.5 ft*			80 + 11.5 ft*			96 + 11.5 ft*			112 + 11.5 ft*			↙ ↘
	80 ft			80 ft			80 ft			80 ft			80 ft			
	82°	75°	68°	82°	75°	68°	82°	75°	68°	82°	75°	68°	82°	75°	68°	
34	85.6															34
36	85.3			80.1												36
38	84.3			79.9												38
40	83.4			79.7			72.9									40
45	81.2			78.9			72.6			64.6			56.3			45
50	79.3	78.7		77.5			72.4			64.4			56.2			50
55	77.5	76.4		76.2	75.4		72			64.4			56.1			55
60	76.2	73.7		75	73.7		71.1	70.4		64.4			56.1			60
65	74.5	71.2	70.1	74.3	71.9		70.5	68.9		64.4	62.5		56.1			65
70	70.6	68.8	67	72.6	70.6		70.3	67.6		64.4	62.4		56.1	54.4		70
75	62.6	67.1	64	68.3	69.5	68.5	70.3	66.7		64.4	61.9		56.1	54.3		75
80	51.6	65.8	61.7	59.7	68.8	66.2	66.2	66	65.1	64.4	61.2		56.1	54.3		80
85		61	59.9	48.5	67.9	64.4	57.4	65.6	63.7	64.3	60.7		56.1	54.3		85
90		49.3	59.4		61.5	62.8		65	61.5	54.4	60.6	58.7	56.1	54.3		90
95			57.7		50.8	60.4		61.7	57.9		60.1	55.7		54.3	52.1	95
100						57			54.6		56.8	52.6		53.9	49.3	100
105									51.6			49.7		51.5	46.6	105
110									48.9			47.1			44.2	110
115												44.7			41.9	115
120															39.9	120

* adapter - pièce d'adaptateur

t_240_004_50301_00_000



↙ ↘	128 + 11.5 ft*			144 + 11.5 ft*			160 + 11.5 ft*			176 + 11.5 ft*			192 + 11.5 ft*			208 + 11.5 ft*			224 + 11.5 ft*		↙ ↘
	80 ft			80 ft			80 ft			80 ft			80 ft			80 ft			80 ft		
	82°	75°	68°	82°	75°	68°	82°	75°	68°	82°	75°	68°	82°	75°	68°	82°	75°	68°	82°	75°	
50	48.5																				50
55	48.5			40.4			30.4														55
60	48.4			40.4			30.2			24.3											60
65	48.4			40.3			30.1			24.3			19								65
70	48.4			40.3			29.9			24.2			19			13.5			8.4		70
75	48.4	46.9		40.3			29.7			24.1			18.9			13.3			8.3		75
80	48.4	46.9		40.3			29.6			24			18.9			13.2			8.1		80
85	48.4	47		40.3	38.7		29.6			23.9			18.9			13.1			8		85
90	48.4	47		40.3	38.5		29.6	28.8		23.9			18.9			13			8		90
95	48.4	47		40.3	38.4		29.6	28.7		23.9	23.2		18.9			12.9			7.9		95
100		47			38.4		29.6	28.6		23.9	23.2		18.9			12.9			7.9		100
105		47	45		38.2			28.6			23.1		17.7			12.9			7.9		105
110		47	42.6		37.8	34.5		28.6			23.1		17.6			11.7					110
115			40.5		37.2	33.8		28.6			23.1		17.5			11.7					115
120			38.5			32.8		28.6	27.1		23.1		17.4			11.6			6.8		120
125			36.7			31.9			26.3		23.1		17.4			11.5			6.7		125
130						31			25.6			20.5				11.5			6.7		130
135									25			19.9							6.6		135
140									24.4			19.4				14.8					140
145												18.9				14.4					145
150																14					150
155																	10.3				155

* adapter - pièce d'adaptateur

t_240_004_50301_00_000

Lifting capacities Forces de levage

TN



	48 + 11.5 ft*			64 + 11.5 ft*			80 + 11.5 ft*			96 + 11.5 ft*			112 + 11.5 ft*			
	92 ft			92 ft			92 ft			92 ft			92 ft			
	82°	75°	68°	82°	75°	68°	82°	75°	68°	82°	75°	68°	82°	75°	68°	
38	74.4															38
40	73.8			70.3												40
45	72			69.5			64.4									45
50	70.3			68.5			64			57.4			50.1			50
55	68.8	68.4		67.3			63.4			57.2			50			55
60	67.4	66.7		66.3	65.8		62.9			56.9			49.9			60
65	66.2	64.9		65.2	64.3		62.2	61.5		56.6			49.7			65
70	65.4	63.3		64.5	63		61.5	60.5		56.3	54.8		49.6			70
75	63.9	61.5	60.6	63.9	61.8		61.2	59.4		56.2	54.8		49.6	47.7		75
80	61.2	60	58.2	62.7	60.8	60.4	61	58.6		56.1	54.4		49.6	48.1		80
85	54.8	58.9	56	59.3	60.1	59	61	57.9	57.4	56.1	53.7		49.6	47.9		85
90	46.6	57.7	54.3	52.7	59.6	57.7	57	57.4	56.4	56	53.3		49.6	47.8		90
95	37.4	53.8	52.9	44.6	59.2	56.4	50.4	57.2	55.3	55.5	53	52.1	49.6	47.7		95
100		45.7	52.5		54.3	55.4	40	56.9	54	48.4	52.8	51.4	49.6	47.7	45.1	100
105			51.8		46.9	53.7		54.8	51.3		52.8	49.3		47.7	46.1	105
110						51		47.2	48.6		50.6	46.7		47.7	44	110
115									46.2		47.8	44.4		46.3	41.8	115
120									43.9			42.2		44	39.8	120
125												40.2			37.9	125
130															36.1	130

* adapter - pièce d'adaptateur

t_240_004_50401_00_000



	128 + 11.5 ft*			144 + 11.5 ft*			160 + 11.5 ft*			176 + 11.5 ft*			192 + 11.5 ft*			208 + 11.5 ft*			224 + 11.5 ft*			
	92 ft			92 ft			92 ft			92 ft			92 ft			92 ft			92 ft			
	82°	75°	68°	82°	75°	68°	82°	75°	68°	82°	75°	68°	82°	75°	68°	82°	75°	68°	82°	75°		
55	43.2			36																	55	
60	43.2			36			26.2														60	
65	43.2			36			26.1			21.5											65	
70	43.1			36			25.9			21.4			16.8			11.3					70	
75	43.1			36			25.8			21.3			16.7			11.1				6.5	75	
80	43.1	40.8		36			25.7			21.2			16.5			11				6.4	80	
85	43.1	41.5		36			25.5			21.2			16.4			10.9				6.3	85	
90	43.1	41.8		36	34.4		25.5			21.1			16.3			10.8				6.2	90	
95	43.1	41.8		36	34.5		25.5	24.8		21.1			16.2			10.7				6.1	95	
100	43.1	41.8		36	34.3		25.5	24.7		21.1	20.4		16.2			10.7				6.1	100	
105	43.1	41.8		36	34.3		25.5	24.6		21.1	20.3		16.2			10.6				6	105	
110		41.8	39.3		34.3		25.5	24.6		21.1	20.3		16.2	15		10.6				6	110	
115		41.8	39.8		34.3			24.6			20.3		16.2	14.9		10.6	9.5			6	115	
120		41.8	38.1		34	31		24.6			20.3		16.2	14.8		10.6	9.5			6	120	
125			36.3		33.6	30.4		24.6	23.9		20.3			14.7			9.4				5	125
130			34.6			29.6		24.6	23.7		20.3			14.7			9.3				4.9	130
135			33.1			28.8			23.4		20.3	18.7		14.7			9.3				4.9	135
140			31.6			28.1			22.9			18.2		14.7			9.3				4.9	140
145						27.4			22.3			17.8			13.4						4.9	145
150									21.8			17.3			13.1							150
155												16.9			12.7			8.5				155
160															12.3			8.4				160
165																		8.4				165
170																		8.3				170

* adapter - pièce d'adaptateur

t_240_004_50401_00_000

Lifting capacities Forces de levage

TN



↙ ↘	48 + 11.5 ft*			64 + 11.5 ft*			80 + 11.5 ft*			96 + 11.5 ft*			112 + 11.5 ft*			↙ ↘		
	103 ft			103 ft			103 ft			103 ft			103 ft					
	82°	75°	68°	82°	75°	68°	82°	75°	68°	82°	75°	68°	82°	75°	68°			
45	63.5			60.5												45		
50	62.3			59.9					55.7			49.9				50		
55	61.1			59.2					55.3			49.6			43.7	55		
60	60	59.4		58.5					54.8			49.3			43.5	60		
65	59	58.1		57.7	57.1				54.4			49.1			43.4	65		
70	58.1	56.9		57	56.1				54	53.1		48.8			43.3	70		
75	57.5	55.8		56.5	55.1				53.6	52.7		48.6	47.2		43.2	75		
80	56.6	54.8	54.1	56.1	54.3				53.4	51.9		48.5	47.3		43.2	41.5	80	
85	54.2	53.8	52.4	55.3	53.6	53			53.2	51.3		48.4	47.1		43.1	41.9	85	
90	50.7	53.2	51	53.8	52.9	52			53.2	50.8		48.4	46.8		43.1	41.8	90	
95	45.1	52.2	49.7	49.7	52.6	51.1			53.2	50.3	49.5	48.4	46.5		43.1	41.7	95	
100	38.3	50.2	48.7	43.7	52.3	50.3			48	50.1	48.7	48.3	46.3	44.8	43.1	41.6	100	
105	31	45.1	48.1	37.3	51.7	49.8			41.9	50	48.1	47.5	46.2	44.9	43.1	41.5	105	
110		38.4	47.4		46	49.5			34.7	49.5	47.6	41.3	46.2	44.5	42.6	41.5	39.7	110
115			44.6		39.7	48.2				46.5	46		46.2	44.1	39.1	41.5	40.2	115
120			36.8			45.9				40.1	43.8		45.6	42.3		41.5	39.5	120
125						41.1					41.7		42.5	40.3		41.4	37.7	125
130											39.8			38.5		39.9	36	130
135														36.7			34.4	135
140																	32.9	140
145																	31.4	145

* adapter - pièce d'adaptateur

t_240_004_50501_00_000



↙ ↘	128 + 11.5 ft*			144 + 11.5 ft*			160 + 11.5 ft*			176 + 11.5 ft*			192 + 11.5 ft*			208 + 11.5 ft*			224 + 11.5 ft*			↙ ↘
	103 ft			103 ft			103 ft			103 ft			103 ft			103 ft			103 ft			
	82°	75°	68°	82°	75°	68°	82°	75°	68°	82°	75°	68°	82°	75°	68°	82°	75°	68°	82°	75°	68°	
55	37.9																					55
60	37.9			31.7																		60
65	37.8			31.7			23.2															65
70	37.8			31.6			23			19			14.6									70
75	37.7			31.6			22.9			18.9			14.5			9.4						75
80	37.7			31.6			22.8			18.8			14.4			9.3			5			80
85	37.7	35.9		31.6			22.6			18.7			14.2			9.1			4.9			85
90	37.7	36.2		31.6			22.5			18.7			14.1			9			4.8			90
95	37.7	36.5		31.6	30.1		22.4			18.6			14			9			4.7			95
100	37.7	36.5		31.6	30.4		22.4	21.8		18.6			13.9			8.9			4.7			100
105	37.7	36.5		31.6	30.6		22.4	21.7		18.5	18.1		13.8			8.8			4.6			105
110	37.7	36.5		31.6	30.6		22.4	21.7		18.5	17.9		13.8			8.7			4.6			110
115	37.7	36.6	34.1	31.6	30.6		22.4	21.6		18.5	17.8		13.7	12.8		8.7			4.5			115
120		36.7	34.5	31.6	30.5		22.4	21.6		18.5	17.8		13.7	12.7		8.7	7.8		4.5			120
125		36.6	35		30.5	28.5		21.6			17.8		13.7	12.6		8.7	7.8		4.5			125
130		36.6	34.4		30.5	28.1		21.6			17.8			12.5			7.7		4.5	3.6		130
135		36.6	32.9		30.4	27.4		21.6	21		17.8			12.5			7.6			3.6		135
140			31.4			26.7		21.6	20.9		17.8			12.4			7.6			3.6		140
145			30.1			26.1			20.7		17.8	16.8		12.4			7.5			3.5		145
150			28.8			25.6			20.6			16.4		12.4			7.5			3.5		150
155						25			20.2			16			11.6		7.5			3.5		155
160									19.9			15.6			11.6					3.5		160
165												15.2			11.3							165
170															11							170
175																10.7						175
180																					3.1	180
185																					3.2	185

* adapter - pièce d'adaptateur

t_240_004_50501_00_000

Lifting capacities Forces de levage

TN



	48 + 11.5 ft*			64 + 11.5 ft*			80 + 11.5 ft*			96 + 11.5 ft*			112 + 11.5 ft*			
	115 ft			115 ft			115 ft			115 ft			115 ft			
	82°	75°	68°	82°	75°	68°	82°	75°	68°	82°	75°	68°	82°	75°	68°	
45	56.1															45
50	55.4			52.7			48.9									50
55	54.6			52.2			48.6			43.8						55
60	53.7			51.6			48.2			43.6			38.4			60
65	52.8	52.4		51.1			47.8			43.4			38.4			65
70	52	51.4		50.6	50		47.5			43.1			38.3			70
75	51.2	50.3		50	49.3		47.2	46.3		42.9			38.1			75
80	50.6	49.4		49.4	48.5		46.9	46.2		42.7	41.4		38.1			80
85	50.2	48.6	48.2	49.1	47.8		46.7	45.8		42.6	41.7		38	36.5		85
90	49.3	47.8	47.2	48.8	47.1		46.6	45.2		42.6	41.5		38	36.8		90
95	47.2	47.2	46.1	48.5	46.5	45.9	46.5	44.8		42.5	41.3		38	36.9		95
100	44.3	46.8	44.9	48.1	46.1	45.1	46.5	44.4	43.7	42.5	41.1		38	36.8		100
105	39.6	45.9	43.9	44.7	45.9	44.5	46.2	44.1	43.2	42.5	40.9	39.1	38	36.7		105
110	34.3	44.1	43.2	39.7	45.9	44	42.8	44	42.6	42.4	40.8	39.5	38	36.6		110
115	28.6	40	42.8	34.4	45.5	43.6	38.4	44	42.1	41.6	40.7	39.6	38	36.6	34.7	115
120		35	42.2	27.1	41.7	43.4	32.7	43.7	41.8	37.1	40.7	39.2	37.6	36.6	35.2	120
125			39.6		36.7	43.3		42	41.5		40.7	38.9	35.5	36.6	35.5	125
130			34.4			41.6		37.3	39.7		40.7	38.1		36.6	35.3	130
135						38.2			37.9		38.3	36.4		36.6	34	135
140									36.2			34.8		36.1	32.5	140
145												33.3			31.1	145
150												31.9			29.8	150
155															28.6	155

* adapter - pièce d'adaptateur

t_240_004_50601_00_000



	128 + 11.5 ft*			144 + 11.5 ft*			160 + 11.5 ft*			176 + 11.5 ft*			192 + 11.5 ft*			208 + 11.5 ft*			
	115 ft			115 ft			115 ft			115 ft			115 ft			115 ft			
	82°	75°	68°	82°	75°	68°	82°	75°	68°	82°	75°	68°	82°	75°	68°	82°	75°	68°	
60	33.5																		60
65	33.4			28			20.6												65
70	33.4			28			20.5			16.8									70
75	33.3			28			20.3			16.7			12.3						75
80	33.3			28			20.2			16.6			12.2			7.5			80
85	33.3			28			20.1			16.5			12			7.3			85
90	33.2	31.6		28			20			16.5			11.9			7.2			90
95	33.2	31.8		28			19.9			16.4			11.8			7.2			95
100	33.2	32.1		28	26.6		19.8			16.4			11.7			7.1			100
105	33.2	32.2		28	26.8		19.8	19.3		16.3			11.6			7			105
110	33.2	32.2		28	27		19.8	19.2		16.3	15.9		11.5			6.9			110
115	33.2	32.2		28	27.1		19.8	19.1		16.3	15.8		11.5			6.9			115
120	33.2	32.2	29.8	28	27.2		19.8	19.1		16.3	15.7		11.4	10.6		6.9			120
125	33.2	32.2	30.2	28	27.2		19.8	19		16.3	15.6		11.4	10.5		6.9	6		125
130		32.2	30.6	28	27.2	25	19.8	19		16.3	15.5		11.4	10.4		6.9	6		130
135		32.2	31		27.1	25.2		19		16.3	15.4		11.4	10.3		6.9	5.9		135
140		32.2	30.9		27.1	25.2		19	18.5		15.4			10.3		6.9	5.8		140
145		32.2	29.7		27.1	24.7		19	18.4		15.4			10.2			5.8		145
150			28.5		27.1	24.1		19	18.3		15.4	14.6		10.2			5.8		150
155			27.3			23.6		19	18.2		15.4	14.6		10.2			5.8		155
160			26.2			23.2			18.2			14.5		10.2	9.6		5.8		160
165						22.7			18.1			14.2			9.7		5.8		165
170									17.9			13.9			9.8			5.3	170
175									17.6			13.6			9.7			5.4	175
180												13.3			9.6			5.6	180
185															9.3			5.7	185
190																		5.8	190

* adapter - pièce d'adaptateur

t_240_004_50601_00_000

Lifting capacities Forces de levage

TN



↙ ↘	48 + 11.5 ft*			64 + 11.5 ft*			80 + 11.5 ft*			96 + 11.5 ft*			112 + 11.5 ft*			↙ ↘		
	126 ft			126 ft			126 ft			126 ft			126 ft					
	82°	75°	68°	82°	75°	68°	82°	75°	68°	82°	75°	68°	82°	75°	68°			
50	49.1															50		
55	48.5			46.3						43.1						55		
60	47.9			45.8						42.7			38.6		34	60		
65	47.3			45.4						42.4			38.4		34	65		
70	46.5			45						42.1			38.2		33.9	70		
75	45.8	45.4		44.5	43.9					41.8			38		33.8	75		
80	45.2	44.6		44.1	43.7			41.6	40.6			37.9		33.7	33.7	80		
85	44.6	43.8		43.7	43.1			41.4	40.7			37.7	36.5		33.6	85		
90	44.2	43		43.4	42.5			41.2	40.4			37.6	36.6		33.5	32.2	90	
95	43.8	42.4	42	43.1	41.9			41.1	40.1			37.5	36.6		33.5	32.4	95	
100	43.1	41.8	41.2	42.8	41.4	41		41	39.8			37.5	36.5		33.5	32.5	100	
105	42.1	41.4	40.4	41.9	40.9	40.4		40.7	39.4	38.4		37.5	36.3		33.5	32.5	105	
110	40	41.1	39.7	40.8	40.7	39.7		40.1	39.1	38.5		37.5	36.2		33.5	32.4	110	
115	36	40.7	39	38.4	40.5	39.2		39.2	39	38		37.5	36.1	34.6	33.5	32.4	115	
120	31.6	39.6	38.5	35.3	40	38.8		37.4	38.8	37.6		37.3	36.1	34.9	33.5	32.4	30.5	120
125	26.9	36.4	38.2	31.1	39.1	38.5		34.4	38.6	37.2		36.6	36	34.9	33.5	32.4	30.8	125
130		32.4	37.8	26.2	36.9	38.4		29.9	38.2	37		33.3	36	34.7	33.3	32.4	31.1	130
135		27	36.1		33.2	38.4			37	36.8		28.7	36	34.5	31.7	32.4	31.4	135
140			32.2		28	37.5			33.8	36			35.9	34.2		32.4	31.4	140
145						34.6				34.4			34	33		32.4	30.7	145
150						28.9				33			29.3	31.7		32.4	29.5	150
155										31				30.4			28.3	155
160														29.2			27.1	160
165																	26.1	165

* adapter - pièce d'adaptateur

t_240_004_50701_00_000



↙ ↘	128 + 11.5 ft*			144 + 11.5 ft*			160 + 11.5 ft*			176 + 11.5 ft*			192 + 11.5 ft*			208 + 11.5 ft*			↙ ↘		
	126 ft			126 ft			126 ft			126 ft			126 ft			126 ft					
	82°	75°	68°	82°	75°	68°	82°	75°	68°	82°	75°	68°	82°	75°	68°	82°	75°	68°			
65	29.6																		65		
70	29.6			24.7						18.2									70		
75	29.6			24.7						18.1		14.8							75		
80	29.5			24.7						18		14.7			10.3		5.8		80		
85	29.4			24.6						17.9		14.6			10.1		5.8		85		
90	29.4			24.6						17.8		14.6			10		5.7		90		
95	29.4			24.6						17.7		14.5			9.9		5.6		95		
100	29.3	28.1		24.6						17.7		14.4			9.8		5.5		100		
105	29.3	28.3		24.6	23.4					17.6		14.4			9.7		5.4		105		
110	29.3	28.4		24.6	23.5					17.5	17.1	14.3			9.6		5.4		110		
115	29.3	28.5		24.6	23.7					17.5	16.9	14.3	13.5		9.5		5.3		115		
120	29.3	28.5		24.6	23.9					17.5	16.8	14.2	13.4		9.5		5.3		120		
125	29.3	28.5		24.6	23.9					17.5	16.8	14.2	13.3		9.5	8.6	5.2		125		
130	29.3	28.5	26.5	24.6	24					17.5	16.8	14.2	13.2		9.4	8.6	5.2	4.4	130		
135	29.3	28.4	26.8	24.6	24					17.5	16.8	14.2	13.1		9.4	8.5	5.2	4.4	135		
140	29	28.4	27.2	24.6	24.1	22.1				17.5	16.8	14.2	13.1		9.4	8.4	5.2	4.3	140		
145		28.4	27.5		24.1	22.4				17.5	16.8	16.4	13.1		9.4	8.4	5.2	4.3	145		
150		28.4	27.7		24.1	22.4					16.8	16.3				8.4	5.2	4.2	150		
155		28.4	26.9		24.1	22.2					16.8	16.2		13.1	12.3		8.4	4.2	155		
160			25.9		24.1	21.8					16.8	16.1		13.1	12.5		8.4	4.2	160		
165			24.8			21.4					16.8	16.1		13.1	12.6		8.4	7.9	4.2	165	
170			23.9			21					16	16		13.1	12.6		8.4	8	4.2	170	
175						20.7					16	16			12.5		8.4	8.1	4.2	175	
180						20.1					16	16			12.4		8.2	8.1	4	180	
185											15.9	15.9			12.1		8.3	8.3	4.2	185	
190															11.9		8.3	8.3	4.3	190	
195																	8.1	8.1	4.3	195	
200																		8.1	8.1	4.2	200

* adapter - pièce d'adaptateur

t_240_004_50701_00_000

Lifting capacities Forces de levage

TN



↙ ↘	48 + 11.5 ft*			64 + 11.5 ft*			80 + 11.5 ft*			96 + 11.5 ft*			112 + 11.5 ft*			↙ ↘
	138 ft			138 ft			138 ft			138 ft			138 ft			
	82°	75°	68°	82°	75°	68°	82°	75°	68°	82°	75°	68°	82°	75°	68°	
55	43.2			41												55
60	42.7			40.7												60
65	42.1			40.3												65
70	41.6			40												70
75	41			39.6												75
80	40.5	40.3		39.2	38.6											80
85	40	39.6		38.9	38.5											85
90	39.5	38.9		38.6	38.2											90
95	38.9	38.2		38.3	37.7											95
100	38	37.7	37.6	37.6	37.2											100
105	37.2	37.2	36.8	36.9	36.8	36.4										105
110	35.9	36.7	36.2	35.9	36.5	36										110
115	34.7	35.9	35.6	34.7	36	35.5										115
120	33.2	35	35.1	33.6	35.1	34.9										120
125	31.3	33.8	34.6	32.5	34.3	34.6										125
130	28.5	32.7	33.9	31.1	33.2	34.2										130
135	24.7	31.6	32.9	28	32.1	33.5										135
140	20.1	29.2	31.9	24.2	31.2	32.7										140
145		25.2	30.9		29.3	31.7										145
150			29		26	30.8										150
155						29.9										155
160						27.4										160
165																165
170																170
175																175
180																180

* adapter - pièce d'adaptateur

L_240_004_50801_00_000



↙ ↘	128 + 11.5 ft*			144 + 11.5 ft*			160 + 11.5 ft*			176 + 11.5 ft*			192 + 11.5 ft*			↙ ↘
	138 ft			138 ft			138 ft			138 ft			138 ft			
	82°	75°	68°	82°	75°	68°	82°	75°	68°	82°	75°	68°	82°	75°	68°	
70	26.1			21.9												70
75	26			21.9												75
80	25.9			21.8												80
85	25.9			21.8												85
90	25.8			21.8												90
95	25.8			21.8												95
100	25.8			21.8												100
105	25.7	24.7		21.8												105
110	25.7	24.8		21.8	20.7											110
115	25.7	24.9		21.8	20.8											115
120	25.7	25		21.8	21											120
125	25.7	25		21.8	21.1											125
130	25.7	25		21.8	21.2											130
135	25.7	25	23.1	21.8	21.2											135
140	25.7	24.9	23.3	21.8	21.3											140
145	25.3	24.9	23.6	21.8	21.2	19.4										145
150	24.9	24.9	23.9	21.8	21.2	19.6										150
155		24.9	24.2		21.2	19.9										155
160		24.9	24.3		21.2	20.1										160
165		24.9	24.3		21.2	20										165
170			23.8		21.2	19.7										170
175			22.9			19.4										175
180			22			19.1										180
185			21.2			18.8										185
190						18.3										190
195																195
200																200
205																205



* adapter - pièce d'adaptateur

L_240_004_50801_00_000

Lifting capacities Forces de levage

TN



	48 + 11.5 ft*			64 + 11.5 ft*			80 + 11.5 ft*			96 + 11.5 ft*			112 + 11.5 ft*			
	149 ft			149 ft			149 ft			149 ft			149 ft			
	82°	75°	68°	82°	75°	68°	82°	75°	68°	82°	75°	68°	82°	75°	68°	
60	37.8			35.9												60
65	37.4			35.7			33.3			30.1						65
70	36.9			35.4			33.1			30			26.5			70
75	36.5			35.1			32.8			29.8			26.3			75
80	36.1			34.8			32.6			29.7			26.3			80
85	35.8	35.5		34.5	33.7		32.4			29.5			26.2			85
90	35.4	35.1		34.3	33.7		32.2	31.3		29.4			26.1			90
95	35	34.5		34	33.6		32.1	31.4		29.3	28.2		26			95
100	34.6	34		33.8	33.3		31.9	31.4		29.2	28.3		26	25		100
105	34.3	33.5	33.4	33.6	33		31.8	31.2		29.1	28.4		25.9	25.1		105
110	34.1	33.1	32.9	33.5	32.7	31.7	31.7	31.1		29	28.4		25.9	25.2		110
115	33.8	32.6	32.2	33.3	32.4	31.9	31.6	30.9		29	28.3		25.9	25.3		115
120	33.6	32.3	31.7	33.2	32.1	31.6	31.6	30.7	29.5	29	28.2		25.9	25.2		120
125	33.3	32.1	31.3	33	31.9	31.2	31.5	30.6	29.7	29	28.1	26.4	25.9	25.1		125
130	31.4	32	30.9	32.4	31.7	30.9	31.5	30.5	29.8	29	28	26.7	25.9	25.1		130
135	28.6	32	30.7	30.5	31.7	30.6	30.8	30.4	29.6	29	28	26.9	25.9	25.1	23.5	135
140	25.7	31.3	30.5	28.3	31.7	30.4	29.7	30.3	29.4	29	28	27.1	25.9	25.1	23.7	140
145	22.6	29.2	30.4	25.5	31.2	30.2	27.8	30.3	29.2	28.9	28	27.2	25.9	25.1	24	145
150	19.2	26.5	30.2	22.3	29.6	30.1	24.8	30.2	29	27	28	27.1	25.9	25.1	24.3	150
155		23.4	29.1		27.3	30.1	21.4	29.7	29	24.2	28	27.1	25.6	25.1	24.3	155
160		18.7	26.8		24	29.8		27.8	29		28	27	24.1	25.1	24.3	160
165			23.1			28.5		24.6	28.7		27.6	27		25.1	24.3	165
170						25.3			27.6		25.1	26.4		25.1	24.3	170
175									26.4			25.4		24.9	23.8	175
180												24.4			22.9	180
185												23.5			22	185
190															21.2	190



* adapter - pièce d'adaptateur

t_240_004_50901_00_000

Lifting capacities Forces de levage

TN



	128 + 11.5 ft*			144 + 11.5 ft*			160 + 11.5 ft*			176 + 11.5 ft*			192 + 11.5 ft*			
	149 ft			149 ft			149 ft			149 ft			149 ft			
	82°	75°	68°	82°	75°	68°	82°	75°	68°	82°	75°	68°	82°	75°	68°	
70	23.1															70
75	23.1			19.4												75
80	23			19.4			14.1									80
85	23			19.4			14			10.9			6.8			85
90	22.9			19.3			14			10.8			6.7			90
95	22.9			19.3			13.9			10.7			6.6			95
100	22.8			19.3			13.8			10.6			6.5			100
105	22.8			19.3			13.8			10.4			6.4			105
110	22.8	21.8		19.3			13.7			10.3			6.3			110
115	22.8	21.9		19.3	18.3		13.7			10.3			6.3			115
120	22.8	22.1		19.3	18.4		13.6	13.3		10.2			6.2			120
125	22.8	22.1		19.3	18.5		13.6	13.2		10.1	9.5		6.1			125
130	22.8	22.1		19.3	18.6		13.6	13.1		10.1	9.4		6.1			130
135	22.8	22.2		19.3	18.7		13.5	13		10	9.3		6.1	5.4		135
140	22.8	22.2	20.3	19.3	18.8		13.5	12.9		10	9.2		6	5.3		140
145	22.8	22.2	20.5	19.3	18.8		13.5	12.8		10	9.2		6	5.2		145
150	22.8	22.2	20.7	19.3	18.8	17	13.5	12.8		10	9.2		6	5.2		150
155	22.8	22.3	21	19.3	18.8	17.2	13.5	12.8		10	9.2		6	5.2		155
160	22.8	22.3	21.2	19.3	18.7	17.4	13.5	12.8	12.5	10	9.2		6	5.2		160
165		22.3	21.4	19.3	18.7	17.7	13.5	12.8	12.5	10	9.2		6	5.2		165
170		22.3	21.6		18.7	17.8		12.8	12.4	10	9.2	8.9	6	5.2		170
175		22.3	21.7		18.7	17.9		12.8	12.4		9.2	9		5.2		175
180		22.3	21.7		18.7	17.8		12.8	12.4		9.2	9.2		5.2	5.1	180
185			21		18.7	17.6		12.8	12.3		9.2	9.3		5.2	5.2	185
190			20.2			17.3			12.3		9.2	9.3		5.2	5.3	190
195			19.4			17.1			12.3			9.2		5.2	5.3	195
200						16.7			12.3			9.2			5.4	200
205									12.3			9.2			5.3	205
210												9.2			5.3	210
215												9.1			5.3	215
220															5.3	220

* adapter - pièce d'adaptateur

t_240_004_50901_00_000

Lifting capacities Forces de levage

TN



↙ ↘	48 + 11.5 ft*			64 + 11.5 ft*			80 + 11.5 ft*			96 + 11.5 ft*			112 + 11.5 ft*			128 + 11.5 ft*			144 + 11.5 ft*			160 + 11.5 ft*			176 + 11.5 ft*			↙ ↘
	161 ft			161 ft			161 ft			161 ft			161 ft			161 ft			161 ft			161 ft			161 ft			
	82°	75°	68°	82°	75°	68°	82°	75°	68°	82°	75°	68°	82°	75°	68°	82°	75°	68°	82°	75°	68°	82°	75°	68°	82°	75°	68°	
65	33.3			31.7			29.4			26.5																		65
70	33			31.5																								70
75	32.6			31.2			29.2			26.3			23.4			20.5												75
80	32.3			31			29			26.2			23.3			20.4			17.1									80
85	32			30.7			28.8			26.1			23.3			20.4			17.1			12.3			9.1			85
90	31.6	31.3		30.5	29.7		28.6			26			23.2			20.3			17.1			12.3			8.9			90
95	31.3	31.2		30.3	29.7		28.5	27.6		25.8			23.1			20.3			17			12.2			8.8			95
100	30.9	30.7		30	29.7		28.3	27.6		25.7	24.8		23			20.2			17			12.1			8.7			100
105	30.6	30.3		29.8	29.5		28.2	27.6		25.7	24.9		23	22.1		20.2			17			12.1			8.6			105
110	30.3	29.8	29.4	29.7	29.3		28.1	27.6		25.6	25		23	22.2		20.2			17			12.1			8.5			110
115	30.1	29.5	29.3	29.5	29.1		27.9	27.5		25.5	25		22.9	22.3		20.2	19.3		17			12			8.4			115
120	29.9	29.1	28.9	29.4	28.8	27.9	27.9	27.3		25.4	24.9		22.9	22.3		20.2	19.4		17	16.2		12			8.3			120
125	29.8	28.8	28.4	29.2	28.5	28	27.8	27.2	25.8	25.4	24.8		22.9	22.3		20.2	19.5		17	16.3		11.9	11.4		8.2			125
130	29.7	28.6	28	29	28.3	27.9	27.7	27	26	25.3	24.7	23.1	22.9	22.3		20.2	19.6		17	16.3		11.9	11.3		8.2	7.6		130
135	29.5	28.4	27.6	28.7	28.1	27.6	27.4	26.9	26.1	25.1	24.7	23.3	22.9	22.2		20.2	19.6		17	16.4		11.8	11.2		8.1	7.5		135
140	27.8	28.3	27.3	28.1	28	27.3	27.2	26.9	26.1	25	24.6	23.5	22.9	22.2	20.7	20.2	19.6		17	16.5		11.8	11.1		8.1	7.4		140
145	25.6	28.3	27.1	26.9	27.9	27.1	26.8	26.8	26.1	24.8	24.6	23.7	22.8	22.2	20.8	20.2	19.6	17.8	17	16.5		11.8	11.1		8.1	7.4		145
150	23.2	27.7	26.9	25.4	27.9	26.9	26.3	26.7	25.9	24.7	24.6	23.9	22.8	22.2	21.1	20.2	19.6	17.9	17	16.5		11.8	11.1		8.1	7.4		150
155	20.6	26.1	26.9	23	27.5	26.7	25.1	26.6	25.8	24.6	24.4	23.9	22.7	22.2	21.3	20.2	19.6	18.1	17	16.6	14.9	11.8	11.1		8.1	7.4		155
160	17.8	24	26.9	20.4	26.5	26.6	22.6	26.5	25.7	24	24.3	23.8	22.7	22.2	21.5	20.2	19.6	18.3	17	16.6	15	11.8	11.1		8.1	7.4		160
165		21.4	26.1	17.2	24.7	26.6	20	26.4	25.6	22.9	24.2	23.8	22.7	22.2	21.5	20.2	19.6	18.5	17	16.6	15.2	11.8	11.1	10.8	8.1	7.4		165
170		18	24.4		22.1	26.5		25.1	25.6	20.3	24.2	23.8	21.8	22.2	21.5	20.2	19.6	18.7	17	16.6	15.4	11.8	11.1	10.8	8.1	7.4		170
175			21.6			25.8		22.6	25.6		24.2	23.8		22.2	21.6		19.6	18.9	17	16.6	15.6	11.8	11.1	10.8	8.1	7.4	7.2	175
180						23.4		19	25.2		24	23.8		22.2	21.6		19.6	19		16.6	15.8		11.1	10.7	8.1	7.4	7.3	180
185									24.2			23.4		22.1	21.5		19.6	19		16.6	15.9		11.1	10.6		7.4	7.4	185
190									21.8			22.6			20.9		19.6	19		16.6	15.9		11.1	10.6		7.4	7.5	190
195												21.8			20.1		18.9		16.6	15.7		11.1	10.6		7.4	7.6	195	
200															19.4		18.4		16.6	15.5		11.1	10.6		7.4	7.5	200	
205																	17.7		16.6	15.4		10.6			7.4	7.5	205	
210																			16.6	15.1		10.6			7.5	7.5	210	
215																						10.6			7.5	7.5	215	
220																						10.6			7.5	7.5	220	
225																									7.5	7.5	225	

* adapter - pièce d'adaptateur

t_240_004_51001_00_000

Lifting capacities Forces de levage

TN



	48 + 11.5 ft*			64 + 11.5 ft*			80 + 11.5 ft*			96 + 11.5 ft*			112 + 11.5 ft*			128 + 11.5 ft*			144 + 11.5 ft*			160 + 11.5 ft*			176 + 11.5 ft*					
	172 ft			172 ft			172 ft			172 ft			172 ft			172 ft			172 ft			172 ft			172 ft					
	82°	75°	68°	82°	75°	68°	82°	75°	68°	82°	75°	68°	82°	75°	68°	82°	75°	68°	82°	75°	68°	82°	75°	68°	82°	75°	68°			
65	29.8																										65			
70	29.5			28.1			26.1																					70		
75	29.2			27.9			25.9			23.5			20.8															75		
80	28.9			27.6			25.7			23.4			20.8			18.1												80		
85	28.6			27.4			25.6			23.3			20.7			18.1			15.1			10.7						85		
90	28.3			27.2			25.4			23.1			20.6			18			15.1			10.6			7.3			90		
95	28	27.6		27			25.2			23			20.6			18			15.1			10.6			7.1			95		
100	27.7	27.6		26.8	26.2		25.1	24.3			22.9			20.5			17.9			15.1		10.5			7			100		
105	27.4	27.3		26.6	26.3		25	24.3			22.8	22		20.4			17.9			15		10.4			6.9			105		
110	27.1	27		26.4	26.1		24.8	24.3			22.7	22		20.4	19.6		17.9			15		10.3			6.8			110		
115	26.8	26.6		26.3	26		24.7	24.3			22.7	22.1		20.3	19.7		17.9			15		10.2			6.8			115		
120	26.7	26.3	25.9	26.1	25.7		24.6	24.2			22.6	22.1		20.3	19.7		17.8	17.1		15		10.1			6.7			120		
125	26.5	25.9	25.8	25.9	25.5	24.5	24.3	24.1			22.5	22.1		20.3	19.8		17.8	17.2		15	14.2	10			6.6			125		
130	26.3	25.6	25.5	25.7	25.4	24.6	24.1	24	22.7		22.4	22		20.3	19.8		17.8	17.2		15	14.3	10	9.4		6.5			130		
135	26.1	25.4	25.1	25.4	25.2	24.7	23.9	23.8	22.8		22.3	22		20.3	19.7		17.8	17.3		15	14.3	9.9	9.4		6.5	5.7		135		
140	25.9	25.2	24.8	25.2	25	24.6	23.7	23.7	22.9		22.2	21.9	20.5	20.3	19.7		17.8	17.3		15	14.3	9.9	9.3		6.4	5.7		140		
145	25.6	25.1	24.5	25	24.9	24.4	23.4	23.5	23		22	21.8	20.6	20.2	19.7	18.1	17.8	17.3		15	14.3	9.9	9.2		6.4	5.7		145		
150	24.3	25	24.3	24.5	24.8	24.2	23.2	23.3	23		21.8	21.7	20.8	20.1	19.6	18.3	17.8	17.3		15	14.3	9.9	9.2		6.4	5.7		150		
155	22.8	25	24.1	23.7	24.6	24	23.1	23.1	22.9		21.7	21.6	21	20.1	19.6	18.4	17.8	17.3	15.7	15	14.3	9.9	9.2		6.4	5.8		155		
160	20.9	24.5	23.9	22.9	24.4	23.8	23	22.9	22.8		21.6	21.5	21.1	20	19.6	18.6	17.8	17.3	15.8	15	14.3	9.9	9.2		6.4	5.9		160		
165	18.7	23.3	23.9	20.8	24	23.7	22.4	22.7	22.7		21.5	21.4	21.1	19.9	19.6	18.8	17.8	17.3	16	15	14.3	13.1	9.9	9.2		6.4	6		165	
170	16.3	21.7	23.8	18.6	23.5	23.7	21	22.6	22.6		21.2	21.2	21.1	19.9	19.6	18.9	17.8	17.3	16.2	15	14.3	13.2	9.9	9.2	9.1	6.4	6.1		170	
175		19.5	23.3	16.1	22.4	23.7	19.1	22.5	22.4		20.6	21.1	21	19.9	19.5	19	17.8	17.3	16.4	15	14.3	13.4	9.9	9.2	9.2	6.4	6.2		175	
180		16.9	22.1		20.2	23.7		22.2	22.3		18.6	21.1	20.9	19.5	19.4	19	17.8	17.3	16.6	15	14.3	13.6	9.9	9.2	9.2	6.4	6.3	5.7		180
185			19.9		17.4	23.2		21.3	22.2			21.1	20.8		19.4	19	17.8	17.3	16.7	15	14.3	13.7	9.9	9.2	9.2	6.4	6.4	5.8		185
190			16.5			21.4		18.8	22.2			21.1	20.7		19.4	19		17.3	16.8		14.3	13.9	9.9	9.2	9.2	6.4	6.5	5.9		190
195						18.4			22.2			19	20.7		19.4	19		17.3	16.8		14.3	14.1		9.2	9.2		6.5	6		195
200									21.1				20.7		19.3	19		17.3	16.8		14.3	14.1		9.2	9.2		6.4	6.1		200
205												20				18.4		16.8			14.3	14.1		9.2	9.2		6.4	6.2		205
210																17.7		16.7				14		9.2	9.2		6.4	6.4		210
215																					16.2		13.9		9.2		6.4	6.5		215
220																					15.6		13.7		9.2		6.4			220
225																						13.2		9.2			6.4			225
230																							9.2				6.4			230
235																							9.2				6.4			235

* adapter - pièce d'adaptateur

t_240_004_51101_00_000

Lifting capacities Forces de levage

TN



↙ ↘	48 + 11.5 ft*			64 + 11.5 ft*			80 + 11.5 ft*			96 + 11.5 ft*			112 + 11.5 ft*			128 + 11.5 ft*			144 + 11.5 ft*			160 + 11.5 ft*			↙ ↘
	184 ft			184 ft			184 ft			184 ft			184 ft			184 ft			184 ft			184 ft			
	82°	75°	68°	82°	75°	68°	82°	75°	68°	82°	75°	68°	82°	75°	68°	82°	75°	68°	82°	75°	68°	82°	75°	68°	
70	26.1																							70	
75	25.9			24.7			23																	75	
80	25.6			24.5			22.9			20.8			18.4											80	
85	25.3			24.3			22.7			20.6			18.3			15.9								85	
90	25.1			24.1			22.6			20.5			18.3			15.9			13.2			8.9		90	
95	24.8			23.9			22.4			20.4			18.2			15.9			13.2			8.8		95	
100	24.6	24.1		23.7			22.3			20.3			18.1			15.8			13.2			8.7		100	
105	24.3	24.1		23.5	23		22.2	21.5		20.2			18.1			15.8			13.2			8.6		105	
110	24	24		23.3	23		22	21.5		20.1			18			15.8			13.1			8.5		110	
115	23.7	23.8		23	22.9		21.8	21.5		20.1	19.4		18	17.3		15.7			13.1			8.4		115	
120	23.4	23.5		22.7	22.8		21.7	21.5		20	19.5		17.9	17.3		15.7			13			8.3		120	
125	23.1	23.2	22.6	22.5	22.6		21.5	21.4		19.9	19.5		17.9	17.4		15.7	15		12.9			8.2		125	
130	22.9	22.9	22.6	22.2	22.4	21.4	21.3	21.3		19.8	19.5		17.9	17.4		15.7	15		12.9	12		8.2		130	
135	22.6	22.7	22.5	22	22.1	21.4	21	21.1		19.7	19.4		17.8	17.4		15.7	15.1		12.8	12		8.1	7.4	135	
140	22.3	22.4	22.2	21.7	21.8	21.5	20.8	20.9	19.9	19.5	19.4		17.8	17.4		15.7	15.1		12.7	12		8.1	7.4	140	
145	22.1	22.1	21.9	21.4	21.6	21.5	20.6	20.7	20	19.3	19.3	17.9	17.7	17.3		15.7	15.2		12.7	12		8.1	7.4	145	
150	21.8	21.9	21.7	21.2	21.3	21.4	20.4	20.5	20.1	19.1	19.1	18	17.7	17.3	15.8	15.7	15.2		12.7	12.1		8.1	7.5	150	
155	21.6	21.6	21.5	21	21.1	21.2	20.2	20.2	20.2	19	19	18.1	17.5	17.3	16	15.7	15.1		12.7	12.2		8.1	7.5	155	
160	21.2	21.5	21.3	20.8	20.8	21	20	20	20.1	18.8	18.9	18.3	17.4	17.2	16.1	15.7	15.1	13.7	12.7	12.3		8.1	7.6	160	
165	20.8	21.3	21.1	20.7	20.6	20.7	19.9	19.8	19.9	18.6	18.7	18.5	17.3	17.1	16.2	15.6	15.1	13.8	12.7	12.4		8.1	7.7	165	
170	19.7	21.1	21	20.6	20.5	20.5	19.8	19.7	19.7	18.5	18.5	18.5	17.2	17.1	16.4	15.6	15.1	13.9	12.7	12.6	11.3	8.1	7.8	170	
175	17.7	21	20.9	19.2	20.3	20.3	19.4	19.5	19.5	18.5	18.4	18.3	17.1	17	16.5	15.5	15.1	14.1	12.7	12.7	11.4	8.1	7.9	175	
180	15.6	20.4	20.8	17.6	20.3	20.2	18.6	19.4	19.4	18.4	18.2	18.2	17	16.9	16.6	15.5	15.1	14.2	12.7	12.7	11.6	8.1	8	7.5	180
185	13	18.5	20.8	15.6	19.9	20	17.4	19.4	19.2	18.3	18.1	18.1	17	16.8	16.6	15.4	15.1	14.4	12.7	12.8	11.7	8.1	8	7.6	185
190		16.2	20.4		19	20	15.2	19.3	19.1	17	18.1	18	17	16.7	16.6	15.4	15.1	14.6	12.7	12.8	11.9	8.1	8.1	7.7	190
195			18.9		16.9	20		19.1	19.1		18.1	17.9	16	16.7	16.5	15.3	15.1	14.7	12.7	12.7	12	8.1	8.1	7.7	195
200			16.5			19.7		17.3	19.1		18.1	17.8		16.7	16.5		15.1	14.8		12.7	12.2	8.1	8.1	7.7	200
205						18			19.1		17.3	17.8		16.7	16.4		15.1	14.8		12.7	12.4		8.1	7.7	205
210									18.8			17.8		16.7	16.4		15.1	14.8		12.7	12.5		8.1	7.8	210
215												17.8			16.4		15.1	14.8		12.7	12.5		8.1	7.8	215
220															16.1			14.9			12.4		8.1	7.8	220
225															15.6			14.7			12.2			7.8	225
230																		14.1			12.2			7.9	230
235																				11.8				7.9	235
240																								8	240

* adapter - pièce d'adaptateur

t_240_004_51201_00_000

Lifting capacities Forces de levage

TN



	48 + 11.5 ft*			64 + 11.5 ft*			80 + 11.5 ft*			96 + 11.5 ft*			112 + 11.5 ft*			128 + 11.5 ft*			144 + 11.5 ft*			160 + 11.5 ft*			
	195 ft			195 ft			195 ft			195 ft			195 ft			195 ft			195 ft			195 ft			
	82°	75°	68°	82°	75°	68°	82°	75°	68°	82°	75°	68°	82°	75°	68°	82°	75°	68°	82°	75°	68°	82°	75°	68°	
75	22.9			21.8																				75	
80	22.6			21.6																					80
85	22.4			21.4																					85
90	22.2			21.3																					90
95	22			21.1																					95
100	21.8			20.9																					100
105	21.5	21		20.7																					105
110	21.3	21		20.6	20.1																				110
115	21	20.9		20.4	20.1																				115
120	20.7	20.8		20.1	20																				120
125	20.3	20.5		19.8	20																				125
130	20.1	20.2	19.6	19.5	19.7																				130
135	19.8	20	19.6	19.3	19.4																				135
140	19.6	19.7	19.6	19.1	19.2	18.7																			140
145	19.3	19.4	19.6	18.8	19	18.7																			145
150	19.1	19.2	19.3	18.6	18.7	18.7																			150
155	18.9	18.9	19.1	18.4	18.5	18.6																			155
160	18.7	18.7	18.8	18.2	18.3	18.4																			160
165	18.5	18.5	18.6	18	18.1	18.2																			165
170	18.4	18.3	18.4	17.8	17.9	17.9																			170
175	18.2	18.2	18.2	17.7	17.7	17.7																			175
180	17.5	18.1	18	17.6	17.6	17.6																			180
185	16	18	17.9	16.8	17.4	17.4																			185
190	14.3	17.6	17.8	15.9	17.3	17.3																			190
195	12.2	16.6	17.7	14.3	17.2	17.2																			195
200		15	17.6		16.9	17.1																			200
205		12.4	17.1		15.6	17.1																			205
210			15.4			17.1																			210
215						16.5																			215
220																									220
225																									225
230																									230
235																									235
240																									240
245																									245
250																									250
255																									255

* adapter - pièce d'adaptateur

t_240_004_51301_00_000

Lifting capacities Forces de levage

TN



↙ ↘	48 + 11.5 ft*			64 + 11.5 ft*			80 + 11.5 ft*			96 + 11.5 ft*			112 + 11.5 ft*			128 + 11.5 ft*			144 + 11.5 ft*			↙ ↘	
	207 ft			207 ft			207 ft			207 ft			207 ft			207 ft			207 ft				
	82°	75°	68°	82°	75°	68°	82°	75°	68°	82°	75°	68°	82°	75°	68°	82°	75°	68°	82°	75°	68°		
80	20.2			19.2																		80	
85	20			19.1						17.8			16.1									85	
90	19.8			18.9						17.7			16			14.2			12.1			90	
95	19.6			18.7						17.5			15.9			14.1			12.1			95	
100	19.4			18.6						17.4			15.8			14.1			12.1		9.8	100	
105	19.1			18.4						17.3			15.8			14			12.1		9.7	105	
110	18.9	18.5		18.2						17.2			15.7			14			12.1		9.6	110	
115	18.6	18.4		18.1	17.7					17.1			15.6			13.9			12.1		9.4	115	
120	18.4	18.4		17.8	17.6					16.9	16.5		15.5			13.9			12		9.3	120	
125	18.1	18.2		17.6	17.6					16.7	16.5		15.4	14.9		13.8			12		9.3	125	
130	17.8	18		17.3	17.5					16.5	16.5		15.3	14.9		13.7	13.3		12		9.2	130	
135	17.5	17.7	17.1	17.1	17.3					16.3	16.5		15.2	15		13.7	13.3		11.9	11.3		135	
140	17.3	17.4	17.1	16.8	17					16.1	16.3		15.1	15		13.7	13.3		11.9	11.3		140	
145	17	17.2	17.1	16.6	16.8	16.2				15.9	16.1		15	14.9		13.6	13.3		11.9	11.4		145	
150	16.8	16.9	17.1	16.4	16.5	16.3				15.7	15.9	15.1	14.8	14.9		13.5	13.3		11.8	11.4		150	
155	16.6	16.7	16.9	16.1	16.3	16.3				15.5	15.7	15.1	14.6	14.7		13.4	13.2		11.8	11.4		155	
160	16.4	16.5	16.6	15.9	16	16.2				15.3	15.4	15.2	14.4	14.6	13.6	13.3	13.2		11.8	11.5		160	
165	16.2	16.2	16.4	15.7	15.8	16				15.1	15.2	15.2	14.2	14.4	13.7	13.2	13.1	12	11.8	11.5		165	
170	16	16	16.1	15.6	15.6	15.8				15	15.1	15.1	14.1	14.2	13.7	13	13	12.1	11.8	11.4		170	
175	15.8	15.8	15.9	15.4	15.4	15.6				14.8	14.9	15	13.9	14	13.8	12.9	12.9	12.2	11.7	11.4	10.3	175	
180	15.7	15.7	15.7	15.3	15.3	15.4				14.7	14.7	14.8	13.8	13.9	13.8	12.8	12.8	12.3	11.6	11.4	10.4	180	
185	15.6	15.5	15.6	15.2	15.2	15.2				14.6	14.5	14.6	13.7	13.7	13.7	12.7	12.7	12.4	11.5	11.4	10.5	185	
190	15.1	15.4	15.4	15	15	15				14.5	14.4	14.5	13.7	13.6	13.6	12.6	12.6	12.4	11.4	11.4	10.6	190	
195	14	15.3	15.3	14.6	14.9	14.9				14.4	14.3	14.3	13.6	13.5	13.5	12.6	12.5	12.4	11.4	11.3	10.7	195	
200	12.9	15.2	15.2	14.1	14.8	14.8				14.4	14.2	14.2	13.6	13.4	13.4	12.5	12.4	12.4	11.4	11.3	10.8	200	
205	11.2	14.6	15.2	13	14.8	14.7				14.1	14.2	14.1	13.6	13.4	13.3	12.5	12.3	12.3	11.4	11.2	10.9	205	
210		13.7	15.1	11.3	14.8	14.7				12.7	14.2	14	13.3	13.3	13.2	12.5	12.3	12.2	11.4	11.2	11	210	
215		11.6	15		14.1	14.6					14.2	14	12.2	13.3	13.2	12.3	12.3	12.2	11.3	11.1	11	215	
220			14.1			14.6					13.8	14		13.3	13.1		12.3	12.1	10.8	11.1	11	220	
225						14.4					12.4	13.9		13.3	13.1		12.3	12.1		11.1	10.9	225	
230												13.9			13.1		12.3	12		11.1	10.9	230	
235												13.8			13.1		12			11.1	10.9	235	
240															13.1		12				10.9	240	
245																	12				10.9	245	
250																					10.9	250	
255																						9.3	255
260																						9.2	260

* adapter - pièce d'adaptateur

t_240_004_51401_00_000

Lifting capacities Forces de levage

TN



↙ ↘	48 + 11.5 ft*			64 + 11.5 ft*			80 + 11.5 ft*			96 + 11.5 ft*			112 + 11.5 ft*			128 + 11.5 ft*			144 + 11.5 ft*			↙ ↘				
	218 ft			218 ft			218 ft			218 ft			218 ft			218 ft			218 ft							
	82°	75°	68°	82°	75°	68°	82°	75°	68°	82°	75°	68°	82°	75°	68°	82°	75°	68°	82°	75°	68°					
80	17.9																					80				
85	17.8			17						15.7												85				
90	17.7			16.9						15.7			14.2			12.3						90				
95	17.5			16.7						15.6			14.1			12.3			10.4			95				
100	17.3			16.6						15.5			14			12.3			10.4		8.1	100				
105	17.1			16.4						15.4			14			12.2			10.4		8	105				
110	16.9			16.3						15.3			13.9			12.2			10.4		7.9	110				
115	16.7	16.4		16.1						15.2			13.8			12.2			10.4		7.8	115				
120	16.4	16.3		15.9	15.6					15.1			13.7			12.2			10.4		7.6	120				
125	16.2	16.2		15.7	15.6			15	14.5			13.6			12.1			10.4		7.6	125					
130	16	16.1		15.5	15.5			14.8	14.5			13.6	13.1		12.1			10.3		7.5	130					
135	15.7	15.8		15.3	15.4			14.6	14.5			13.5	13.1		12	11.5		10.3		7.4	135					
140	15.4	15.6		15	15.2			14.4	14.5			13.3	13.1		12	11.5		10.3	9.8	7.4	140					
145	15.2	15.4	15.1	14.8	15			14.2	14.4			13.2	13.1		12	11.6		10.3	9.9	7.4	6.8	145				
150	15	15.1	15.1	14.6	14.7	14.2		14	14.2			13.1	13.1		11.9	11.6		10.3	9.9	7.4	6.8	150				
155	14.8	14.9	15	14.4	14.5	14.3		13.8	14	13.2		13	13		11.9	11.5		10.3	9.9	7.4	6.9	155				
160	14.6	14.7	14.8	14.2	14.3	14.3		13.6	13.8	13.2		12.8	12.9		11.7	11.5		10.2	9.9	7.4	7	160				
165	14.4	14.5	14.6	14	14.1	14.2		13.4	13.6	13.3		12.6	12.7	11.9	11.6	11.5		10.2	9.9	7.4	7	165				
170	14.2	14.3	14.4	13.8	13.9	14		13.2	13.3	13.3		12.4	12.6	11.9	11.5	11.4	10.4	10.2	9.9	7.4	7.1	170				
175	14	14.1	14.2	13.7	13.7	13.8		13.1	13.1	13.2		12.3	12.4	12	11.3	11.3	10.5	10.2	9.9	7.4	7.2	175				
180	13.8	13.9	14	13.5	13.5	13.6		13	13	13.1		12.2	12.2	12	11.2	11.2	10.6	10.1	9.9	8.8	7.4	7.3	180			
185	13.7	13.7	13.8	13.3	13.4	13.4		12.8	12.8	13		12.1	12.1	12	11.2	11.2	10.6	10.1	9.9	8.8	7.4	7.3	185			
190	13.6	13.6	13.6	13.2	13.2	13.3		12.7	12.7	12.8		11.9	12	12	11.1	11.1	10.7	10	9.9	8.9	7.4	7.4	7	190		
195	13.5	13.5	13.5	13.1	13.1	13.1		12.6	12.6	12.7		11.9	11.9	11.9	11	11	10.8	9.9	9.8	9	7.4	7.5	7.1	195		
200	13.2	13.4	13.4	13.1	13	13		12.5	12.5	12.5		11.8	11.8	11.8	10.9	10.9	10.8	9.9	9.8	9.1	7.4	7.6	7.2	200		
205	12.4	13.3	13.3	12.8	12.9	12.9		12.5	12.4	12.4		11.8	11.7	11.7	10.9	10.8	10.8	9.8	9.7	9.3	7.4	7.6	7.3	205		
210	11.5	13.2	13.2	12.5	12.8	12.8		12.5	12.3	12.3		11.7	11.6	11.6	10.9	10.7	10.7	9.8	9.7	9.4	7.4	7.5	7.3	210		
215	10.2	12.8	13.1	11.7	12.8	12.7		12.4	12.3	12.2		11.7	11.5	11.5	10.9	10.6	10.6	9.8	9.6	9.4	7.4	7.5	7.4	215		
220		12.4	13.1	10.2	12.8	12.7		11.5	12.2	12.1		11.6	11.5	11.4	10.8	10.6	10.6	9.7	9.6	9.5	7.4	7.5	7.5	220		
225		10.6	13.1		12.5	12.6			12.2	12.1		11.1	11.5	11.4	10.5	10.6	10.5	9.5	9.6	9.5	7.4	7.5	7.5	225		
230			12.7		11.2	12.6			12.2	12.1			11.5	11.3		10.6	10.4	9	9.6	9.4	7.4	7.5	7.6	230		
235			10.7			12.6			11.4	12			11.5	11.3		10.6	10.4		9.6	9.4		7.5	7.5	235		
240						12				12			11.3	11.3		10.6	10.4		9.6	9.3		7.5	7.5	240		
245										12				11.3		10.6	10.3		9.6	9.3		7.5	7.5	245		
250														11.3						9.3		7.5	7.5	250		
255																				9.3			7.5	255		
260																					9.3			7.5	260	
265																						9.3			7.5	265
270																								7.5	270	

* adapter - pièce d'adaptateur

t_240_004_51501_00_000

Lifting capacities Forces de levage

TN



↙ ↘	48 + 11.5 ft*			64 + 11.5 ft*			80 + 11.5 ft*			96 + 11.5 ft*			112 + 11.5 ft*			128 + 11.5 ft*			144 + 11.5 ft*			↙ ↘					
	230 ft			230 ft			230 ft			230 ft			230 ft			230 ft			230 ft								
	82°	75°	68°	82°	75°	68°	82°	75°	68°	82°	75°	68°	82°	75°	68°	82°	75°	68°	82°	75°	68°						
85	15.8																					85					
90	15.6			14.9					13.7													90					
95	15.5			14.7					13.7			12.2			10.5							95					
100	15.3			14.6					13.6			12.1			10.5			8.8			6.5	100					
105	15.1			14.5					13.5			12.1			10.4			8.8			6.4	105					
110	14.9			14.3					13.4			12			10.4			8.8			6.2	110					
115	14.7			14.2					13.3			12			10.4			8.7			6.1	115					
120	14.5	14.2		14					13.2			11.9			10.4			8.7			6	120					
125	14.2	14.2		13.8	13.5				13.1			11.9			10.3			8.7			5.9	125					
130	14	14.1		13.6	13.5			13	12.6			11.8			10.3			8.7			5.9	130					
135	13.8	13.9		13.4	13.4			12.8	12.6			11.7	11.3		10.3			8.6			5.9	135					
140	13.5	13.7		13.1	13.3			12.6	12.5			11.6	11.2		10.3	9.9		8.6			5.8	140					
145	13.3	13.4		12.9	13.1			12.4	12.5			11.5	11.2		10.2	9.9		8.6	8.2		5.8	145					
150	13	13.2	13	12.7	12.9			12.2	12.4			11.4	11.2		10.2	9.9		8.6	8.2		5.8	5.3	150				
155	12.8	13	13	12.5	12.7	12.3	12	12.2				11.2	11.2		10.2	9.9		8.6	8.3		5.8	5.3	155				
160	12.5	12.7	12.9	12.2	12.4	12.3	11.8	12				11.1	11.1		10.1	9.9		8.6	8.3		5.8	5.4	160				
165	12.2	12.4	12.7	12	12.2	12.3	11.6	11.8	11.3			10.9	11		10.1	9.9		8.6	8.4		5.8	5.4	165				
170	12	12.2	12.4	11.7	12	12.2	11.4	11.6	11.4			10.8	10.9	10.1	9.9	9.8		8.6	8.4		5.8	5.5	170				
175	11.7	11.9	12.2	11.5	11.7	12	11.2	11.4	11.4			10.6	10.7	10.2	9.8	9.7		8.6	8.4		5.8	5.5	175				
180	11.5	11.7	11.9	11.3	11.5	11.8	11	11.2	11.4			10.4	10.6	10.2	9.6	9.6	8.8		8.6	8.4		5.8	5.6	180			
185	11.3	11.5	11.7	11.1	11.3	11.5	10.8	11	11.2			10.3	10.4	10.2	9.5	9.5	8.9		8.5	8.4	7.3	5.8	5.7	185			
190	11.1	11.3	11.4	10.9	11.1	11.3	10.6	10.8	11.1			10.1	10.3	10.2	9.4	9.4	9		8.4	8.4	7.4	5.8	5.7	190			
195	11	11.1	11.2	10.7	10.9	11.1	10.4	10.6	10.9			9.9	10.1	10.2	9.3	9.3	9		8.4	8.3	7.4	5.8	5.8	5.5	195		
200	10.9	10.9	11	10.6	10.7	10.9	10.3	10.4	10.7			9.8	9.9	10.1	9.1	9.2	9.1		8.3	8.3	7.5	5.8	5.9	5.6	200		
205	10.7	10.8	10.9	10.5	10.6	10.7	10.2	10.3	10.5			9.7	9.8	9.9	9	9.1	9.1		8.2	8.2	7.6	5.8	6	5.7	205		
210	10.5	10.6	10.7	10.4	10.4	10.5	10	10.1	10.3			9.6	9.7	9.8	8.9	9	9.1		8.2	8.2	7.7	5.8	6	5.8	210		
215	10.3	10.5	10.6	10.3	10.3	10.4	10	10	10.1			9.5	9.5	9.7	8.9	8.9	9		8.1	8.1	7.8	5.8	6	5.8	215		
220	10	10.4	10.4	10.3	10.2	10.2	9.9	9.9	10			9.5	9.4	9.6	8.8	8.8	8.9		8.1	8	7.8	5.8	6	5.9	220		
225	9	10.4	10.4	10	10.1	10.1	9.9	9.8	9.9			9.4	9.3	9.4	8.8	8.7	8.8		8	8	7.8	5.8	6	6	225		
230	7.7	10.4	10.3	9	10.1	10	9.5	9.7	9.7			9.4	9.3	9.3	8.8	8.7	8.7		7.9	7.9	7.8	5.8	6	6	230		
235		9.4	10.3		10.1	10	8.7	9.7	9.7			9.4	9.2	9.2	8.6	8.6	8.6		7.8	7.9	7.8	5.8	6	6	235		
240			10.3		9.6	10		9.7	9.6				9.2	9.1	8	8.6	8.6		7.3	7.9	7.8	5.8	6	6	240		
245						10		9.7	9.6				9.2	9.1		8.6	8.5			7.8	7.7		6	6	245		
250						10			9.6				9.2	9.1		8.6	8.4			7.8	7.7		6	6	250		
255									9.6					9		8.6	8.4			7.8	7.7		6	6	255		
260														9			8.4			7.8	7.7		6	6	260		
265															9					8.4		7.6		6	6	265	
270																				8.4		7.6		6	6	270	
275																					7.6			6	6	275	
280																						7.6			6	6	280

* adapter - pièce d'adaptateur

t_240_004_51601_00_000

Lifting heights Hauteurs de levage

TN

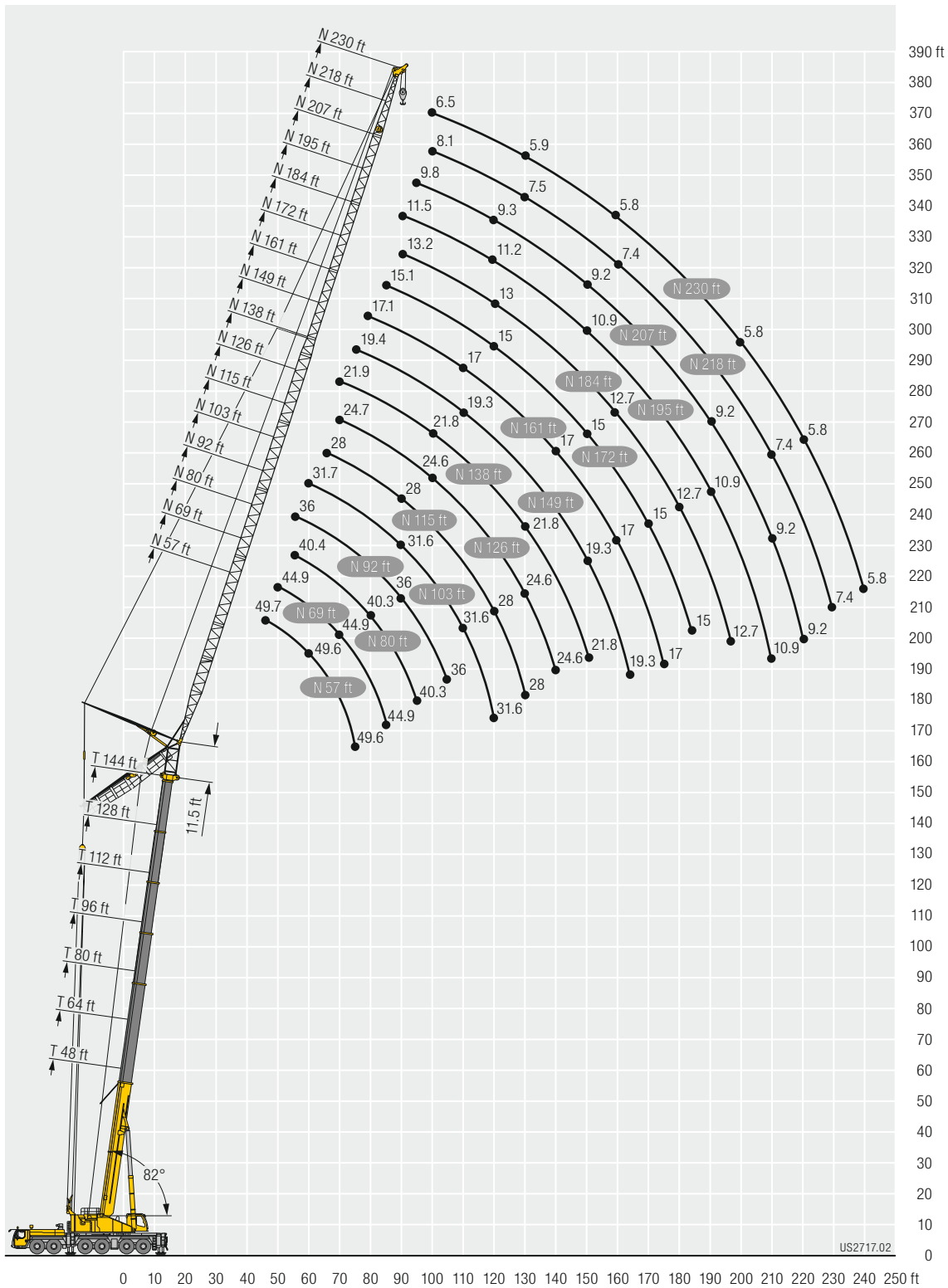

Equipment Equipment

Crane carrier

Frame	Self-manufactured, torsion-resistant box-type design of high-tensile fine grained structural steel.
Outriggers	4-point supporting system, hydraulically telescopic into horizontal and vertical direction. Operation with remote control, automatic support leveling, electronic inclination display.
Engine	8-cylinder Diesel, make Liebherr, watercooled, output 455 kW (619 h.p.), max. torque 2263 lbs-ft. Exhaust emissions acc. to 97/68/EG and EPA/CARB, ECE-R.96. Fuel reservoir: 211 gallons.
Transmission	Automatic transmission system with torque converter and interarder, make ZF with 12 forward speeds and 2 reverse speeds, transfer case with transfer differential.
Axles	Low maintenance carrier axles, all 6 axles steered. Axle 1, 3 and 5 are equipped with planetary gears, all driven axles with transverse differential locks, axle 3 with longitudinal differential lock.
Cardan shaft	All cardan shafts with 70° diagonal toothing and maintenance free.
Suspension	All axles are hydro-pneumatically suspended with automatic leveling. Suspension hydraulically lockable.
Tyres	12 tyres, all axles equipped with single tyres. Size of tyres: 445/95 R 25 (16.00 R 25).
Steering	2-circuit system with hydraulic servo steering. Active speed depending rear axle steering, special steering programs for various driving situations.
Brakes	Service brake: all-wheel servo-air brake, all axles are equipped with disc brakes, dual circuit. Additional brakes: exhaust flap brake, Telma Eddy current brake (optional), interarder in gearbox. Hand brake: Spring-loaded, acting on all wheels of axles 2 to 6.
Driver's cab	Spacious corrosion resistant with comfort furnishings, mounted on rubber shock absorbers, safety glazing.
Electrical system	Modern data bus technique, 24 Volt DC, 2 batteries of 170 Ah each.

Crane superstructure

Frame	Liebherr-manufactured, torsionally rigid steel construction made from high-tensile fine-grain steel. Triple-roller slewing rim.
Crane drive	Mechanical drive of the crane hydraulic from the chassis. Variable axial piston pumps with servo control and power regulation.
Control	Two self-centering control levers (joy-sticks). Pedal switches for telescoping. Infinitely variable crane motions through displacement control of the hydraulic pumps. Additional working speed control by variation of the Diesel engine speed.
Hoist gear	Axial piston variable displacement motor, hoist drum with integrated planetary gear and spring-loaded static brake. Actuation by closed regulated oil circuit.
Luffing gear	1 differential hydraulic ram with nonreturn valve.
Slewing gear	Axial piston fixed displacement motor, planetary gear, spring-loaded static brake. Actuation by closed regulated oil circuit.
Crane cab	Large screen area, compound glass, comfort furnishing, cabin tiltable 20° to rear.
Safety devices	LICCON2 safe load indicator, test system, hoist limit switches, safety valves against rupture of pipes and hoses.

Safety devices	LICCON2 safe load indicator, test system, hoist limit switches, safety valves against rupture of pipes and hoses.
Counterweight	123,500 lbs
Telescopic boom	1 base section and 6 telescopic sections. All telescopic sections extendable individually by means of the rapid-cycle telescoping system TELEMATIK. Boom length 48 ft to 256 ft.

Operating modes

K	Integrated assembly jib of 18 ft (option) Swing away jib 41 ft – 115 ft Adjustment 0°; 20°; 40°
NZK	Hydraulically adjustable swing-away jib 41 ft – 115 ft Hydraulically adjustment 0° – 40°
F	Fixed lattice jib 46 ft – 138 ft Adjustment 0°; 20°; 40°
N	Luffing fly jib 57 ft – 230 ft

Additional equipment

2nd hoist gear	For 2-hook operation or for operating the luffing lattice jib.
Tyres	12 tyres, size 525/80 R 25 (20.5 R 25).
Drive 12 x 8	The 4 th axle is driven additionally.
Additional counterweight	4 additional counterweight slabs of 22,045 lbs each for a total counterweight of 211,600 lbs.

Other items of equipment available on request.

The pictures contain also accessories and special equipment not included in the standard scope of delivery.

Equipment Equipment

Châssis porteur

Cadre	Châssis résistant à la torsion de fabrication Liebherr, en acier à grains fins très résistant.
Calage	Dispositif de calage horizontal et vertical en 4 points, entièrement déployable hydrauliquement. Utilisation avec commande à distance, mise à niveau automatique du calage, inclinomètre électronique.
Moteur	Moteur diesel, 8 cylindres, fabriqué par Liebherr, à refroidissement par eau, de 455 kW (619 ch), couple max. 2263 lbs-ft. Emissions des gaz d'échappement conformes aux directives 97/68/EG et EPA/CARB, ECE-R.96. Capacité du réservoir à carburant: 211 gallons.
Boîte de vitesse	Boîte automatique avec convertisseur de couple et ralentisseur, marque ZF avec 12 marches AV et 2 marches AR, boîte de transfert avec différentiel répartiteur.
Essieux	Essieux nécessitant peu d'entretien, les 6 essieux sont directeurs. Les essieux 1, 3 et 5 sont des essieux planétaires, tous les essieux moteurs avec différentiel transversal et l'essieu 3 avec différentiel longitudinal.
Arbres articulés	Tous les flasques de croisillons avec denture en croix 70° et sans entretien.
Suspension	Tous les essieux sont à suspension hydropneumatique avec mise à niveau automatique. Suspension blocable hydrauliquement.
Pneumatiques	12 roues à monte simple. Taille: 445/95 R 25 (16.00 R 25).
Direction	2 circuits avec direction assistée hydraulique. Direction active des essieux arrière et dépendante de la vitesse, programmes de direction spéciaux pour les différents modes de déplacement.
Freins	Freins de service: servofrein à air comprimé, tous les essieux sont munis de freins à disque, à 2 circuits. Freins auxiliaire : par clapet sur échappement, frein Telma (option), ralentisseur monté sur boîte de vitesse. Frein de secours et frein à main: par cylindres à ressorts sur les essieux 2 à 6.
Cabine	Spacieuse cabine, traitement anticorrosion, équipement «grand confort», suspension par silentbloks, vitrage de sécurité.
Installation électrique	Technique moderne de transmission de données par BUS de données, courant continu 24 Volts, 2 batteries de 170 Ah chacune.

Partie tournante

Cadre	Fabrication Liebherr, construction soudée indéformable, en acier à grain fin haute résistance. Couronne d'orientation à triple rangée de rouleaux.
Entraînement	Entraînement mécanique de l'hydraulique de la grue par le châssis de la grue. Pompes réglables à pistons axiaux avec servocommande et réglage de puissance.
Commande	2 leviers à 4 directions avec rappel automatique au point mort. Commande des mouvements progressive en continu par variation de l'inclinaison des pompes et augmentation du régime moteur.

Mécanisme de levage	Moteur hydraulique à cylindrée variable, treuil avec réducteur planétaire à frein d'arrêt à lamelles intégrées, en circuit hydraulique ferme.
Mécanisme de relevage	1 vérin hydraulique différentiel avec clapet anti-retour de sécurité.
Dispositif de rotation	Moteur à cylindrée constante à pistons axiaux, engrenage planétaire, frein d'arrêt commandé par ressort en circuit hydraulique ferme.
Dispositif de sécurité	Contrôleur de charge LICCON2, système test, fin de course crochet haut, clapets de sécurité en cas de ruptures de flexibles.
Contrepoids	123,500 lbs
Flèche télescopique	Un élément de base et de 6 télescopes. Chaque partie peut être télescopée individuellement à l'aide du système de télescopage séquentiel rapide TELEMATIK. Longueur de flèche: 48 ft – 256 ft.

Modes de fonctionnement

K	Intégrée de 18 ft de long (en option) Fléchette pliante 41 ft – 115 ft Positionnement 0°; 20°; 40°
NZK	Fléchette pliante à positionnement hydraulique 41 ft – 115 ft Positionnement hydraulique à 0° – 40°
F	Fléchette treillis fixe 46 ft – 138 ft Positionnement 0°; 20°; 40°
N	Fléchette treillis à volée variable 57 ft – 230 ft

Équipement supplémentaire



































2ème mécanisme de levage	Pour le travail avec 2 crochets ou le relevage de la fléchette à volée variable.
Pneumatiques	12 pneus. Taille 525/80 R 25 (20.5 R 25).
Entraînement 12 x 8	Le 4ème essieu est également entraîné.
Contrepoids additionnel	4 blocs latéraux de suspension de 22,045 lbs pour un contrepoids total de 211,600 lbs.

Autres équipements supplémentaires sur demande.

Les figures contiennent également des accessoires et des équipements spéciaux non inclus de série dans la livraison.

Description of symbols

Explication des symboles

	Max. capacity Capacité max.		Max. single line pull Effort au brin maxi.
	Max. lifting capacity Capacité max.		Hoist gear Treuil de levage
	Max. radius Portée max.		Slewing speeds Vitesses d'orientation
	Tyres Pneumatiques		Boom length Longueur de la flèche
	Hookblock / Capacity Moufle à crochet / Capacité de charge		Boom position Position de la flèche
	No. of sheaves Poulies		Counterweight Contrepoids
	No. of lines Brins		Axle Essieu
	Weight Poids		Page Page
	Crane carrier Châssis porteur		Outriggers Calage
	Driving speed Vitesse de translation		Slewing gear / Working area Mécanisme d'orientation / Plage de travail
	Gradability Aptitude à gravir les pentes		Standard Norme
	Transmission Boîte de vitesse		Radius Portée
	Gear Vitesse		Telescopic boom Flèche télescopique
	Driving speed – Onroad gear Vitesse de translation – Vitesse de route		Swing away jib Fléchette pliante
	Crane superstructure Partie tournante de la grue		Hydraulic swing away jib Fléchette pliante hydraulique
	infinitely variable en continu		Fixed lattice jib Fléchette treillis fixe
	Rope diameter Diamètre		Luffing fly jib Fléchette treillis à volée variable
	Rope length Longueur du câble		

Remarks

1. The lifting capacities do not exceed 85 % of the tipping load according to ASME B 30.5. The crane's structural steelwork is in accordance with EN 13000 and ASME B 30.5.
2. For the calculation of the load charts at least a wind speed of 30 ft/s (9 m/s, 20 mph) and regarding the load a sail area of 1 m² per ton load and a wind resistance coefficient of 1.2 on the load have been taken into account. For lifting of loads with large sail areas and/or high wind resistance coefficients the maximum wind speed as stated in the load charts has to be reduced.
3. The lifting capacities stated are valid for lifting operation only (corresponding with crane classification according to ISO 4301-1, crane group A1).
4. Lifting capacities are given in kips.
5. The weight of the hook blocks and hooks must be deducted from the lifting capacities.
6. Working radii are measured from the slewing centre.
7. The stated lengths of the telescopic boom are maximum values and may deviate slightly.
8. The lifting capacities given for the telescopic boom apply if the folding jib is removed.
9. Subject to modification of lifting capacities.
10. Lifting capacities above 298,600 lbs / 410,000 lbs only with additional pulley block/special equipment.
11. The data of this brochure serves only for general information. All information is provided without warranty. Instructions for the correct commissioning of the crane please take from the operation manual and the load chart book.

Remarques

1. La capacité de charge ne doit pas dépasser 85 % de la charge de basculement conformément à ASME B 30.5. La structure métallique de la grue est conforme à EN 13000 et ASME B 30.5.
2. Une vitesse de vent de 30 ft/s (9 m/s, 20 mph) minimum, une surface de prise au vent de 1 m² par tonne ainsi qu'un coefficient de résistance au vent de la charge 1,2 sont pris en compte pour le calcul des tableaux de charge. Lorsque des charges ayant une surface de prise au vent et/ou un coefficient de résistance au vent plus élevé(e)s sont levées, la vitesse de vent maximale indiquée dans les tableaux de charge doit être réduite.
3. Forces de levage pour application de grue de montage (correspond à la classification de grues selon ISO 4301-1, groupe de grues A1).
4. Les forces de levage sont données en kips.
5. Les poids des mouffes et crochets doit être soustrait des charges indiquées.
6. Les portées sont calculées à partir de l'axe de rotation.
7. Les longueurs indiquées pour la flèche télescopique sont des valeurs maximales et peuvent légèrement varier dans la réalité.
8. Les charges indiquées pour la flèche télescopique sont valables lorsque la fléchette pliante est démontée.
9. Charges données sous réserve de modification.
10. Forces de levage plus de 298,600 lbs / 410,000 lbs seulement avec moufle additionnel/équipement supplémentaire.
11. Les données de cette brochure sont données à titre informatif. Ces renseignements sont sans garantie. Les consignes relatives à la bonne mise en service de la grue sont disponibles dans le manuel d'utilisation et le manuel de tableaux de charge.

Proposition 65



WARNING: This product can expose you to chemicals, including exhaust emissions, including lead and lead compounds, which are known to the State of California to cause cancer, birth defects or other reproductive harm.
For more information see: www.P65warnings.ca.gov/diesel

Subject to modification / Sous réserve de modifications